

**A****ZELE****S383-POL/135**

A	B	C	D
1	S383-3014	1348	170
2	S383-4003	1350	200

**1**

# 2

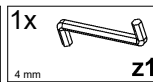
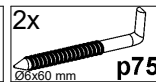
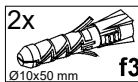
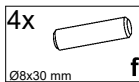
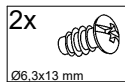
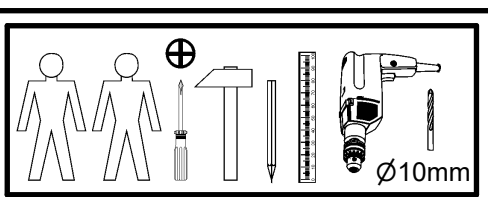
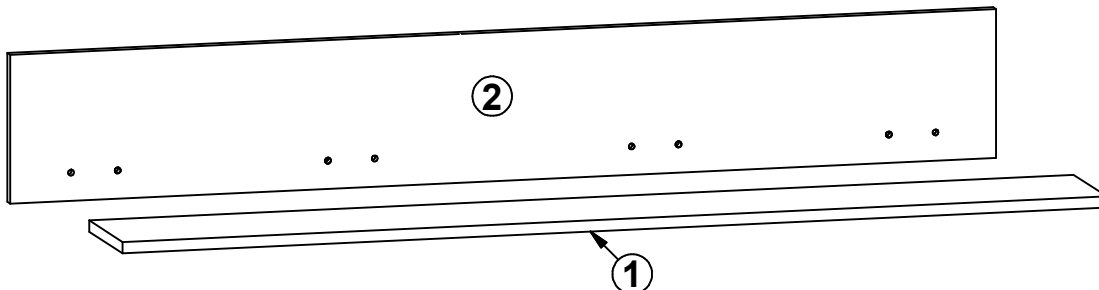
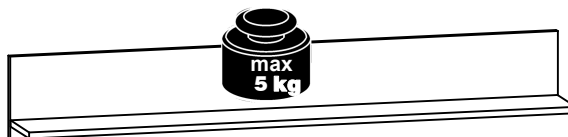
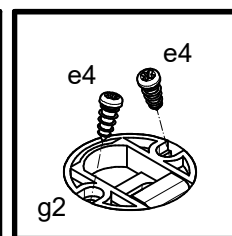
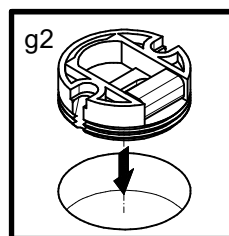
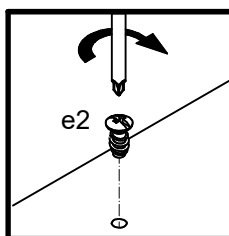
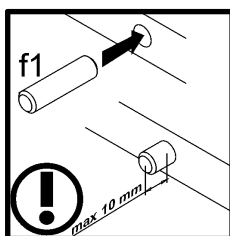
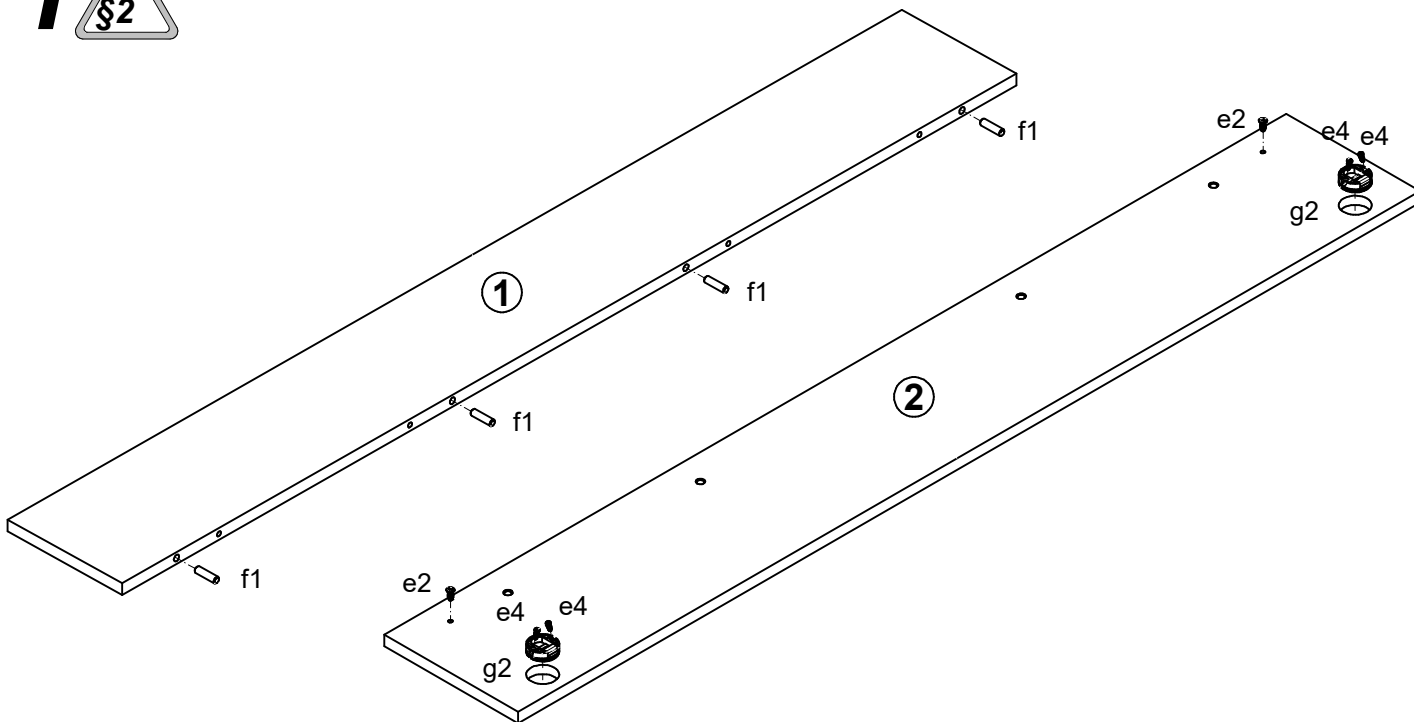
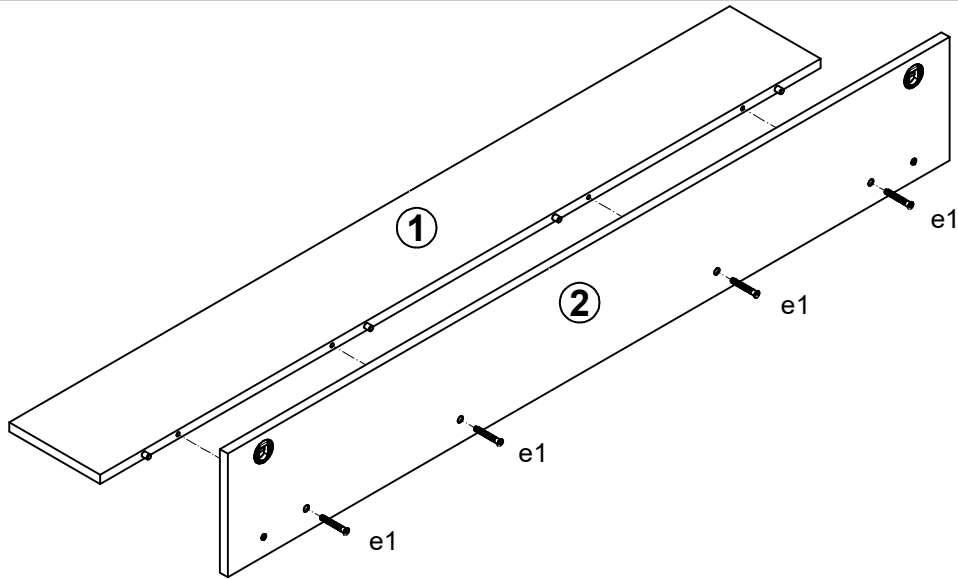

# 3



φ10 mm

