

A	B	C	D
1	S455-0002	1890	460 3/3
2	S455-0003	1890	460 3/3
3	S455-1001	1978	560 2/3
4	S455-1002	1978	560 2/3
5	S455-2002	1013	571 1/3
6	S455-3002	929	537 1/3
7	S455-3003	929	516 1/3
8	S455-9301	1926	939 2/3
9	dr-924	924	30 1/3

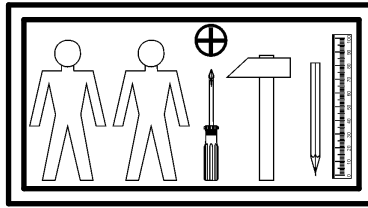

A	B	C	D
10	S455-3004	456	508 1/1
11	S455-1003	1581	516 1/1
12	dr-453	453	22 1/1

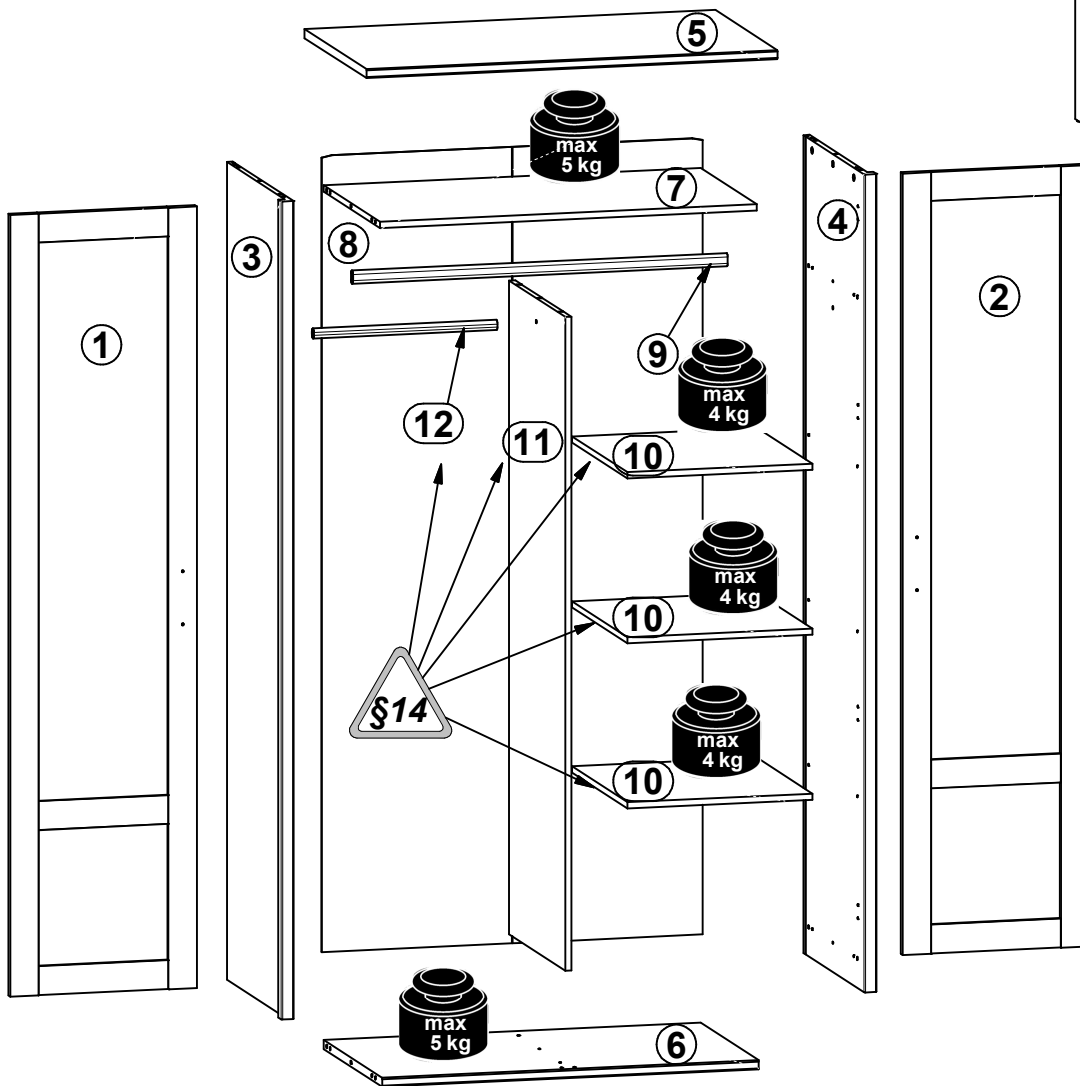
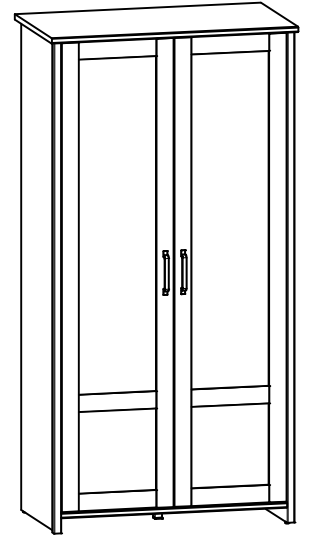

2x a133	8x a160	8x b43	2x c526	2x d5	17x e2
12x f1	4x k1	1x k38l3	1x k38l8	20x l1	12x l2
2x n158	2x p1	4x p9	5x p38	16x p51	18x r1
18x r42	12x s2	1x n26l1			

	6x n108
12x d1	6x p55
6x r36	6x r57

1 §2

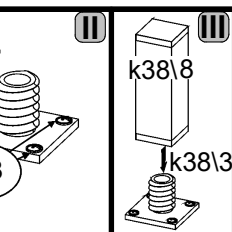
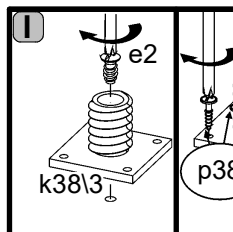
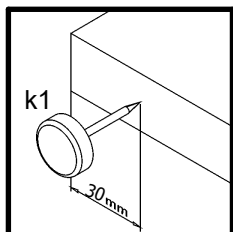
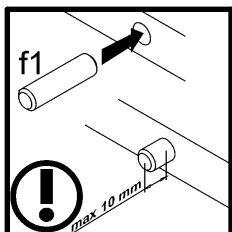
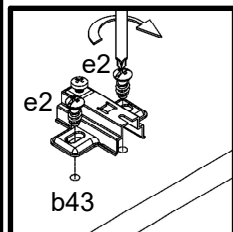
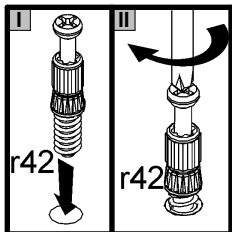
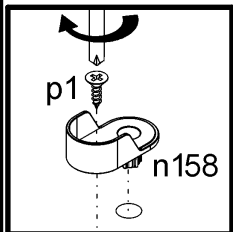
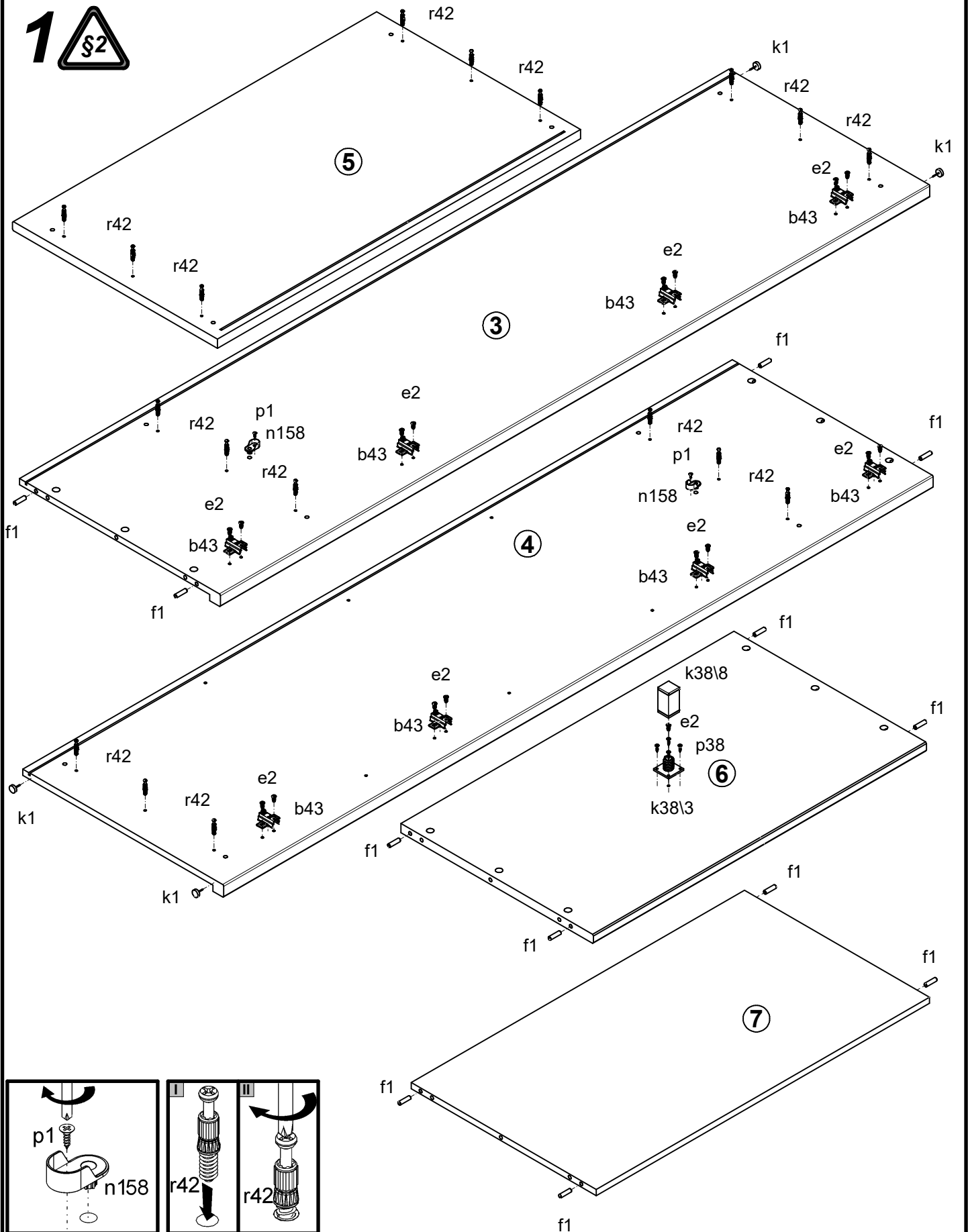

2 §6

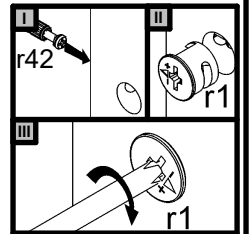
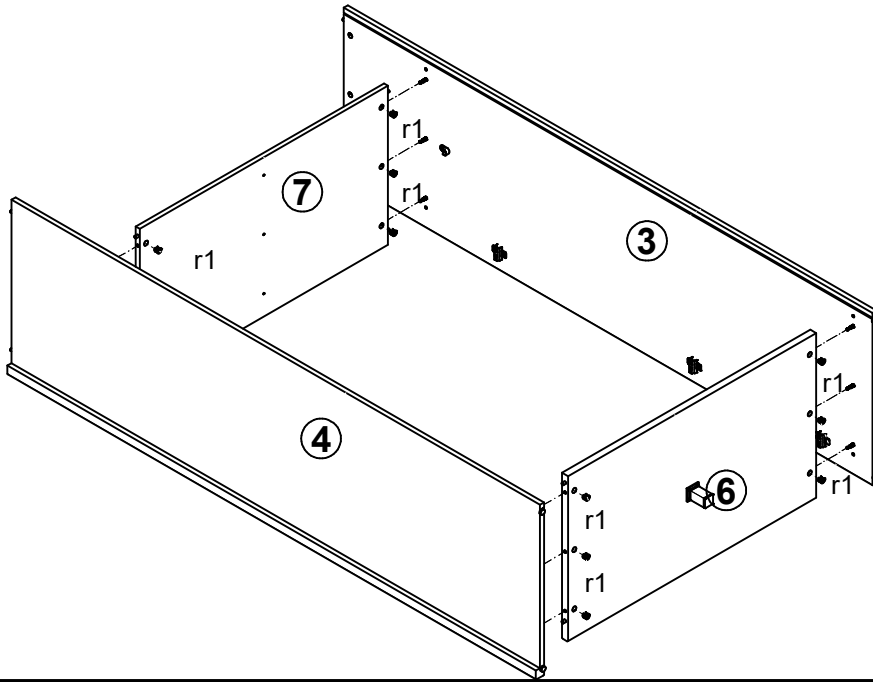

3 §6

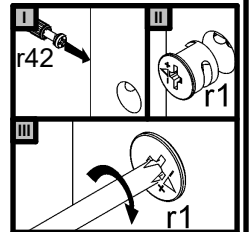
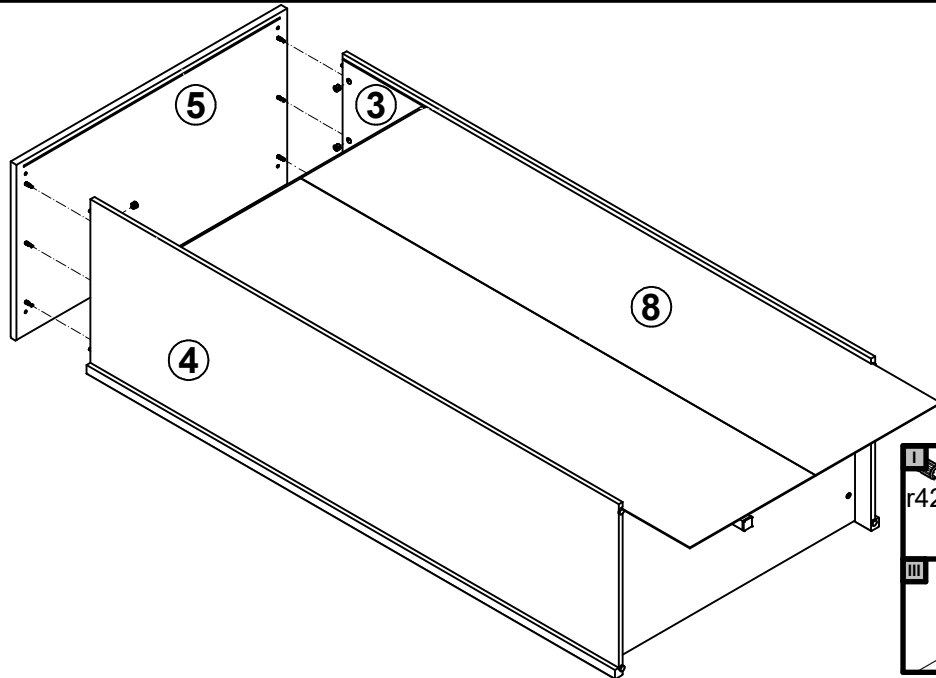

4 §6

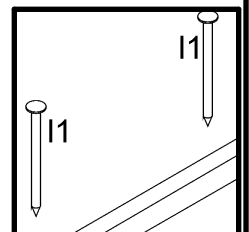
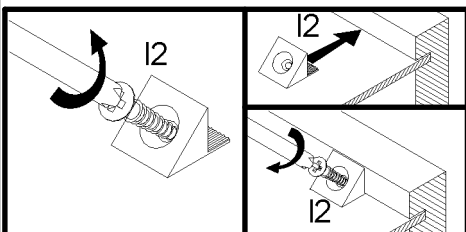
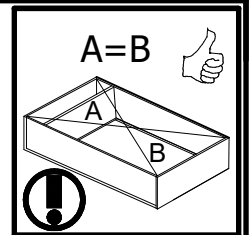
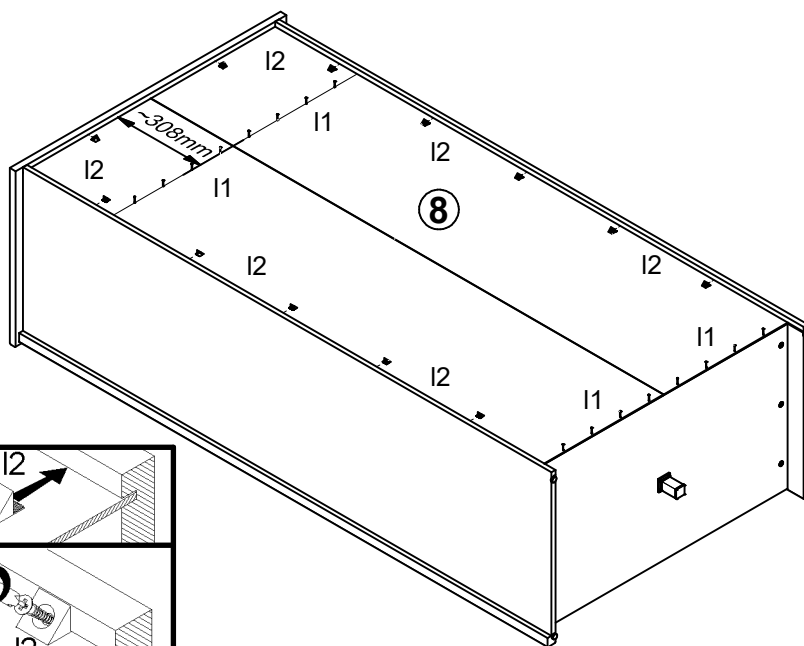

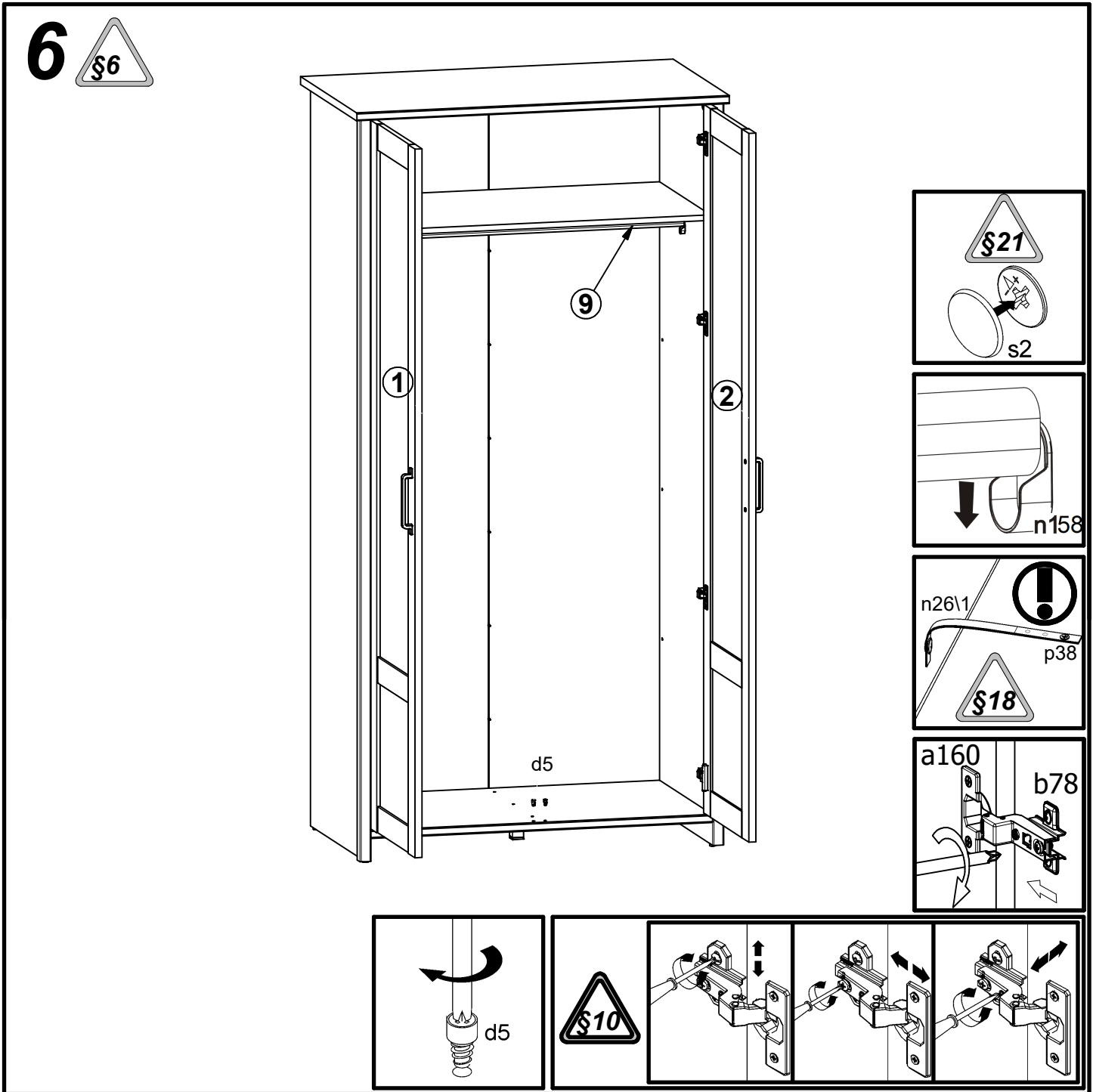
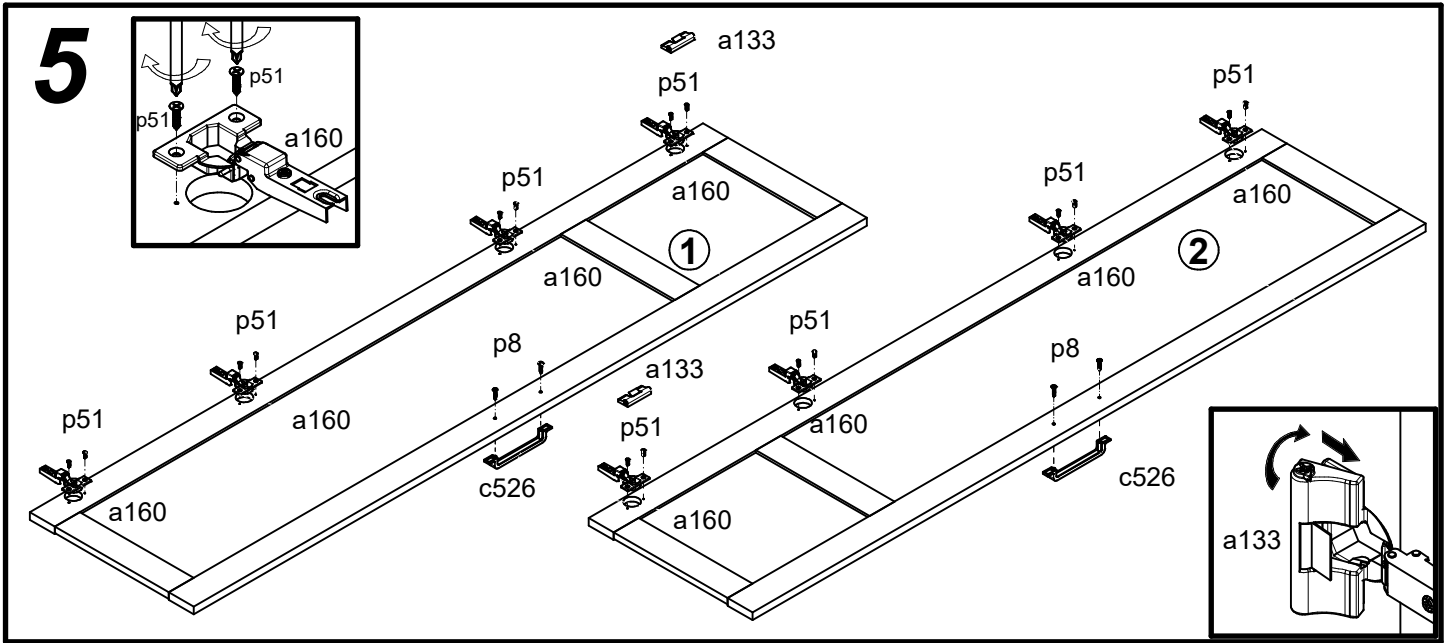

7 §14

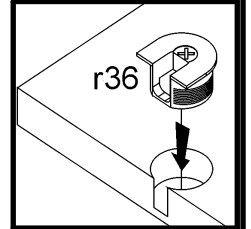
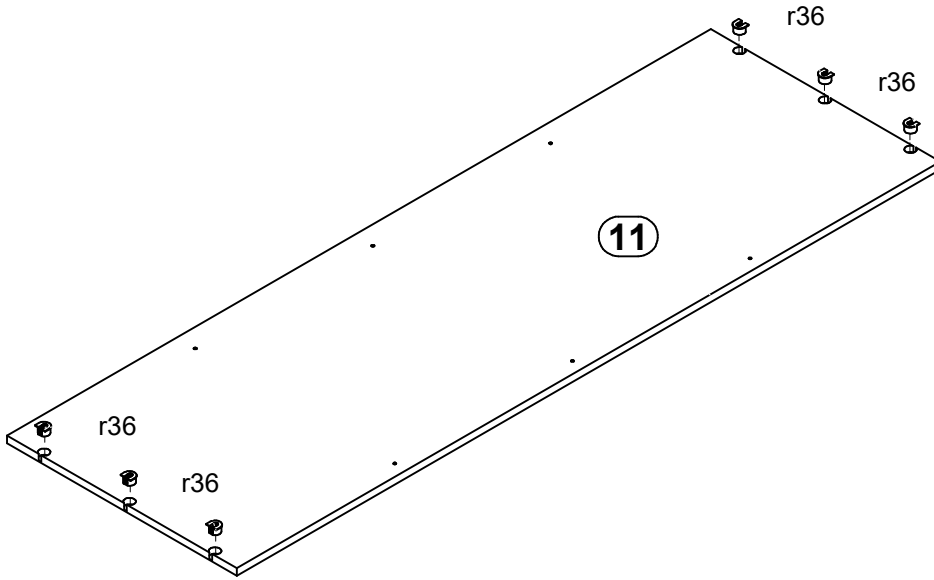

8 §14

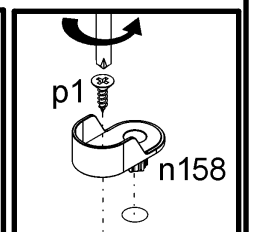
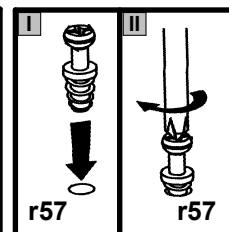
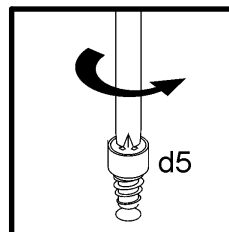
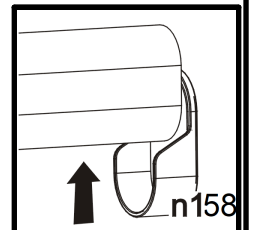
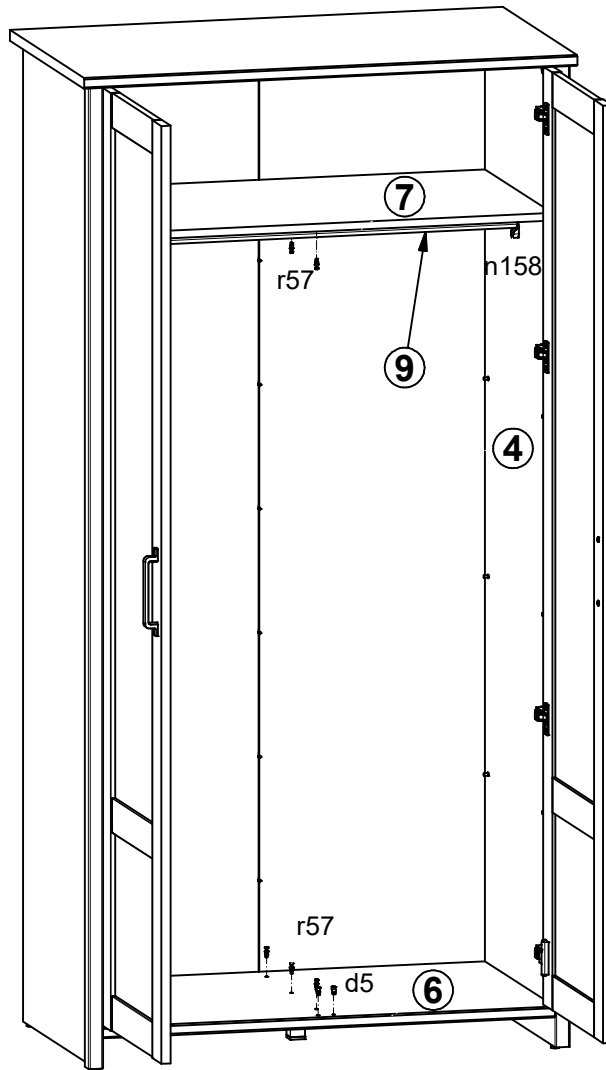

9

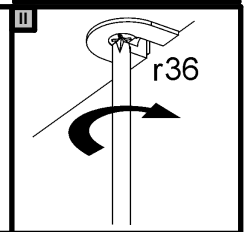
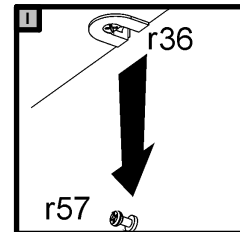
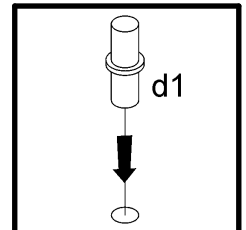
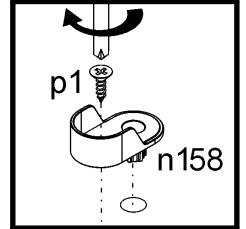
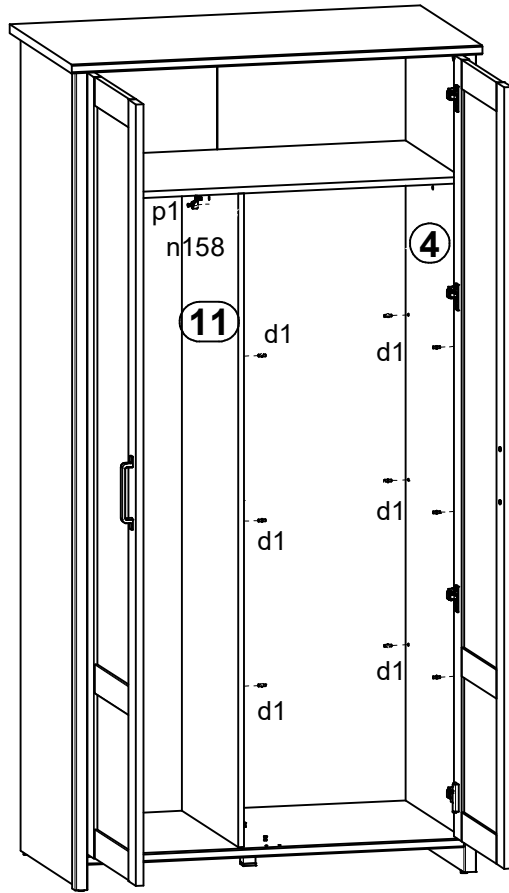

10

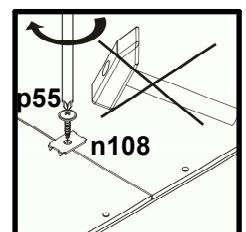
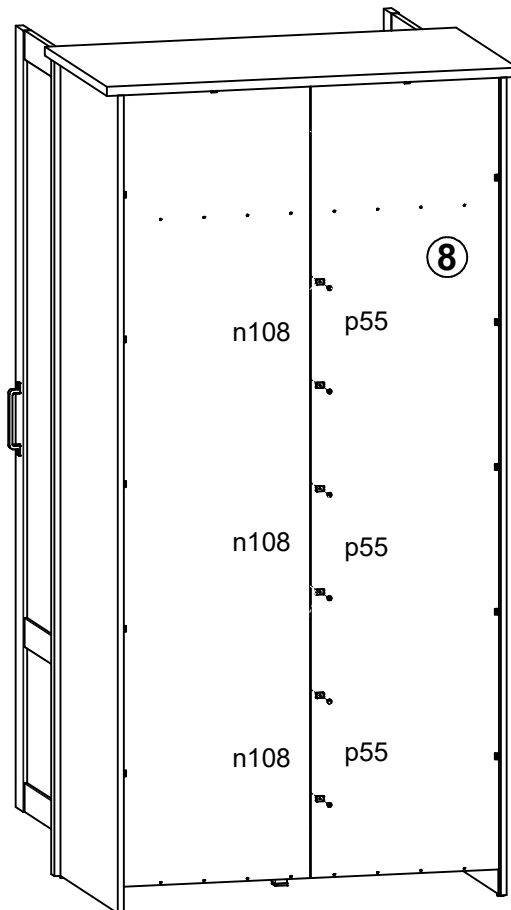

11

