

A

FORN

S471-KOM1D3S

A	B	C	D
1	S471-0001	803	496 2/2
2	S471-0002	1020	265 2/2
3	S471-0003	1020	265 2/2
4	S471-0004	1020	265 2/2
5	S471-1001	811	419 2/2
6	S471-1002	811	419 2/2
7	S471-1003	811	381 1/2
8	S471-2001	1560	422 1/2
9	S471-2002	1560	419 1/2
10	S471-3001	494	375 1/2
11	S471-4001	1480	60 1/2
12	S471-4002	329	60 1/2
13	S471-4007	1019	60 2/2
14	S471-9001	979	357 1/2
15	S471-9002	839	506 2/2
16	S471-9301	839	1031 2/2
17	ZK3-5119	969	127 1/2
18	ZK4-513	350	140 1/2
19	ZK4-514	350	140 1/2

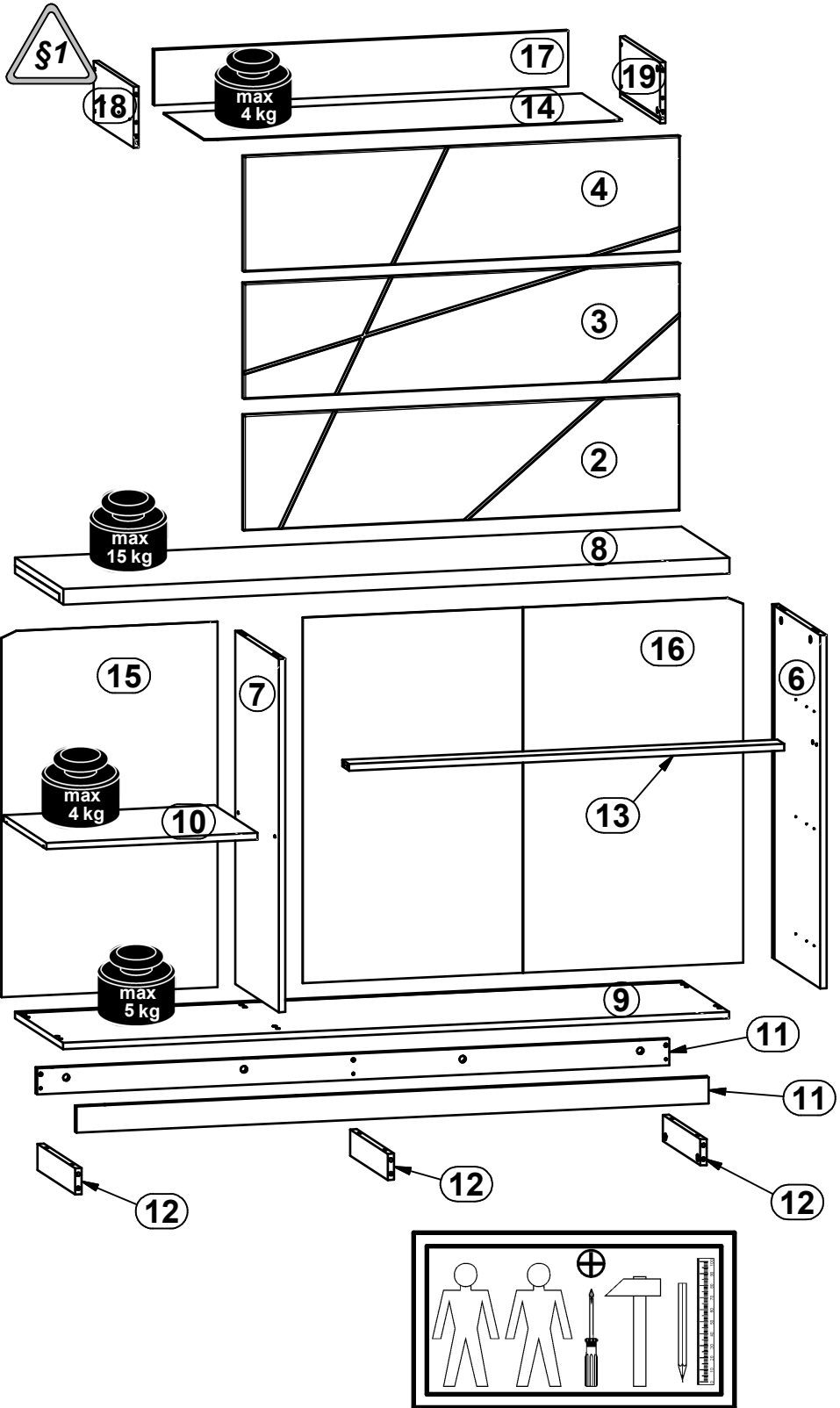

1x a203	1x a210	2x b90	4x c485 84 mm	4x d1 Ø5x17 mm	6x e1 Ø7x50 mm	34x f1 Ø8x30 mm	12x f25 Ø6.5x40 mm	6x f9 Ø6x30 mm
6x k1	10x l2	4x n108 22x9.5x20.7 mm	8x p1 Ø3.5x13 mm	36x p140 Ø3.5x12 mm	6x p25 Ø3.5x16 mm	6x p35 Ø3.5x10 mm	19x p38 Ø3.5x16 mm	4x p51 Ø3.5x15 mm
4x p55 Ø2.9x16 mm	22x r1 Ø15x12 mm #16	12x r15 Ø12x10.5 mm #12	34x r42 20/11	6x t35 350 mm	6x w210\1 L-350 mm	6x w210\2 L-350 mm	2x s68 Ø 20mm	1x z1 4 mm
1x n26\1								

1 

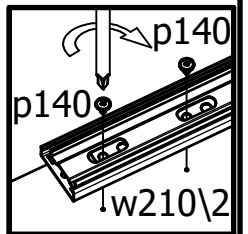
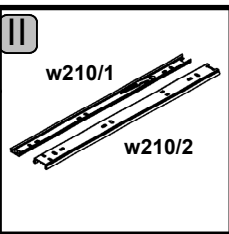
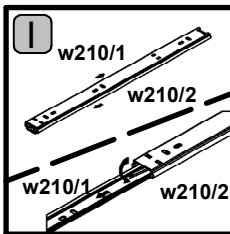
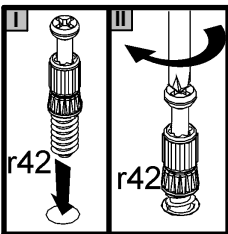
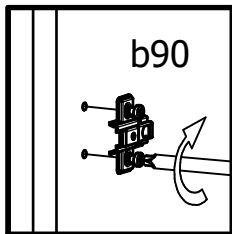
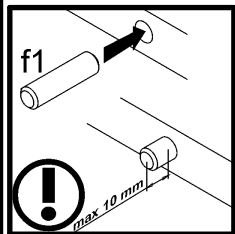
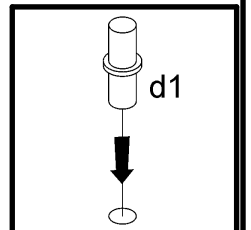
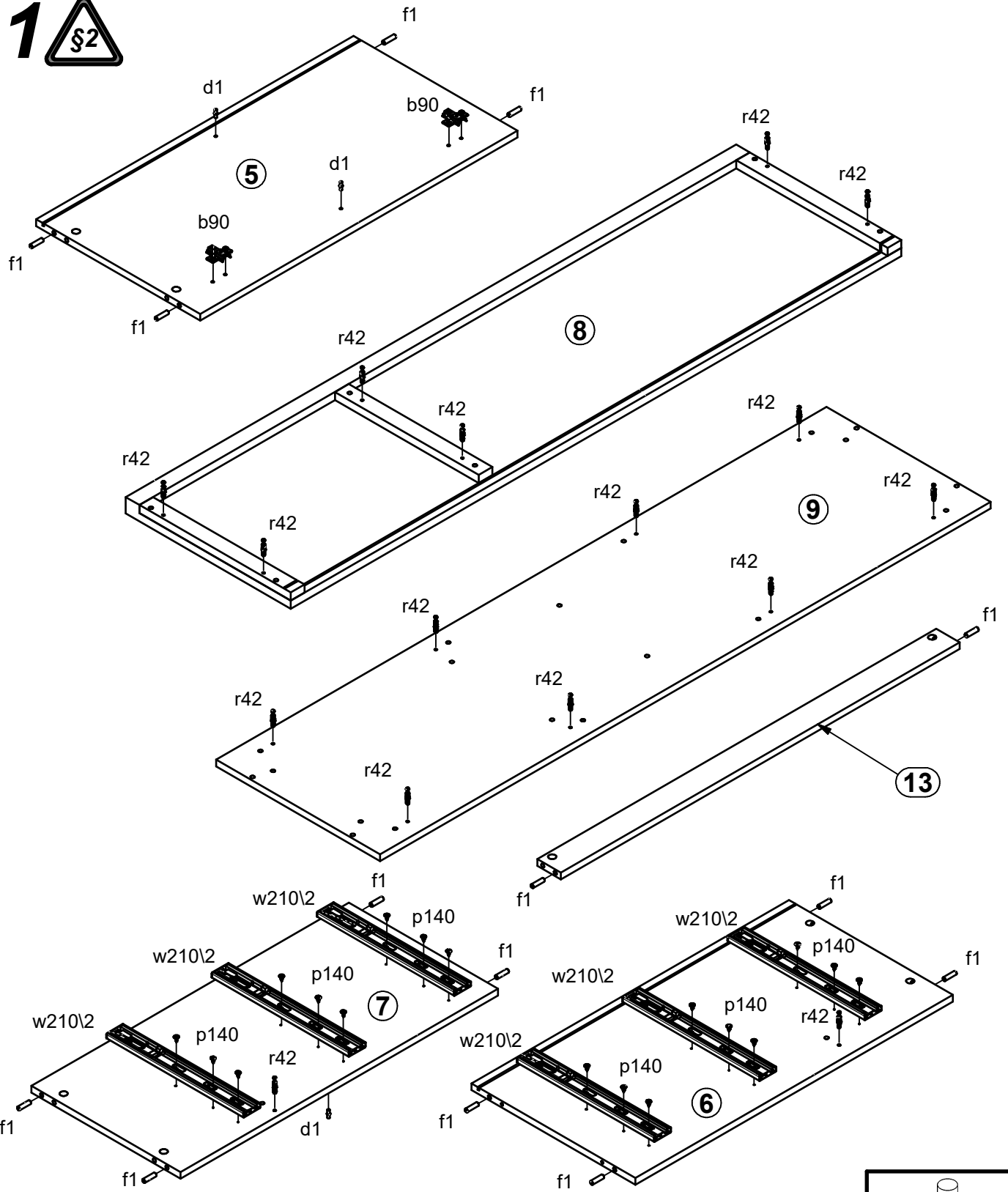

2

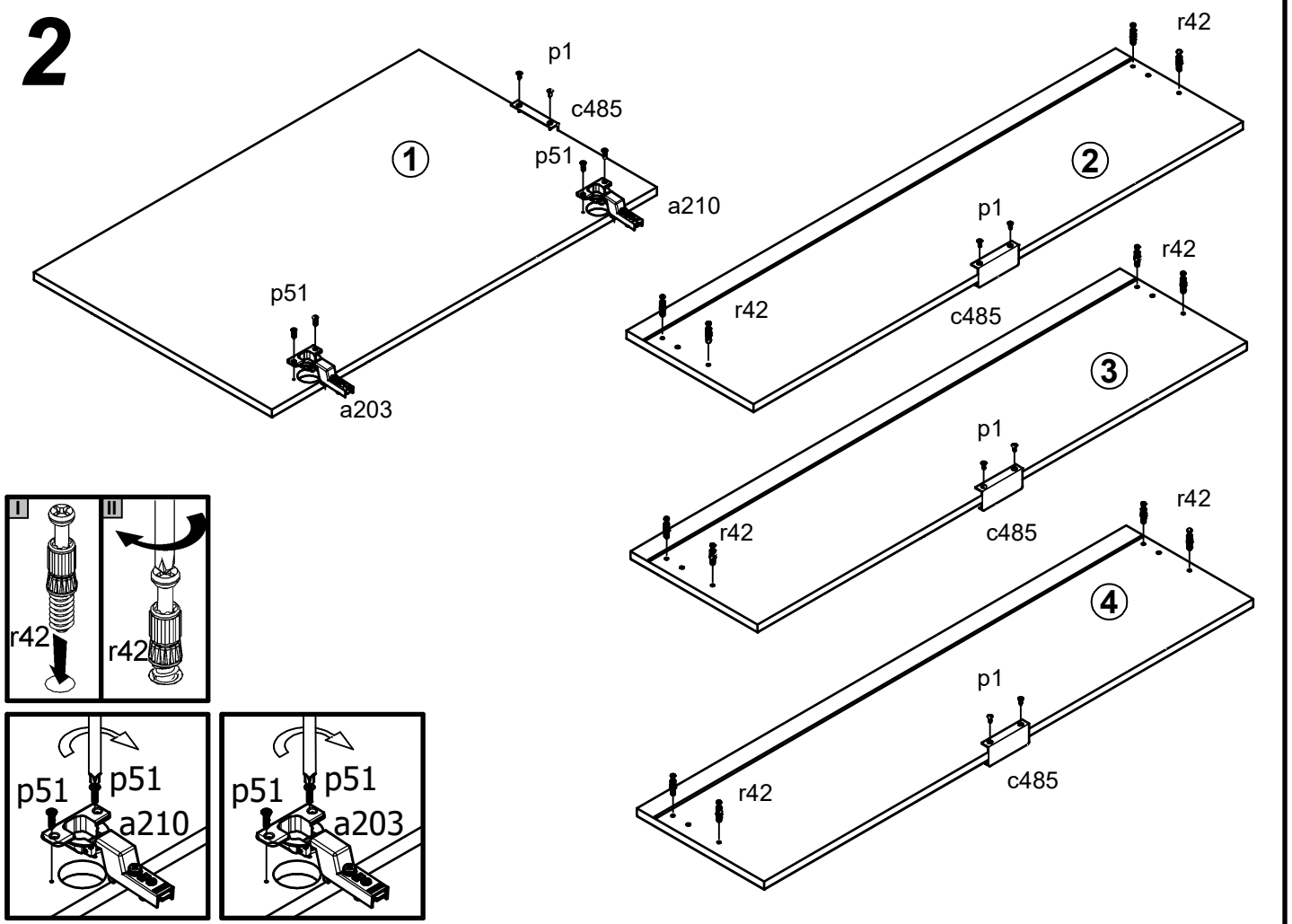

3

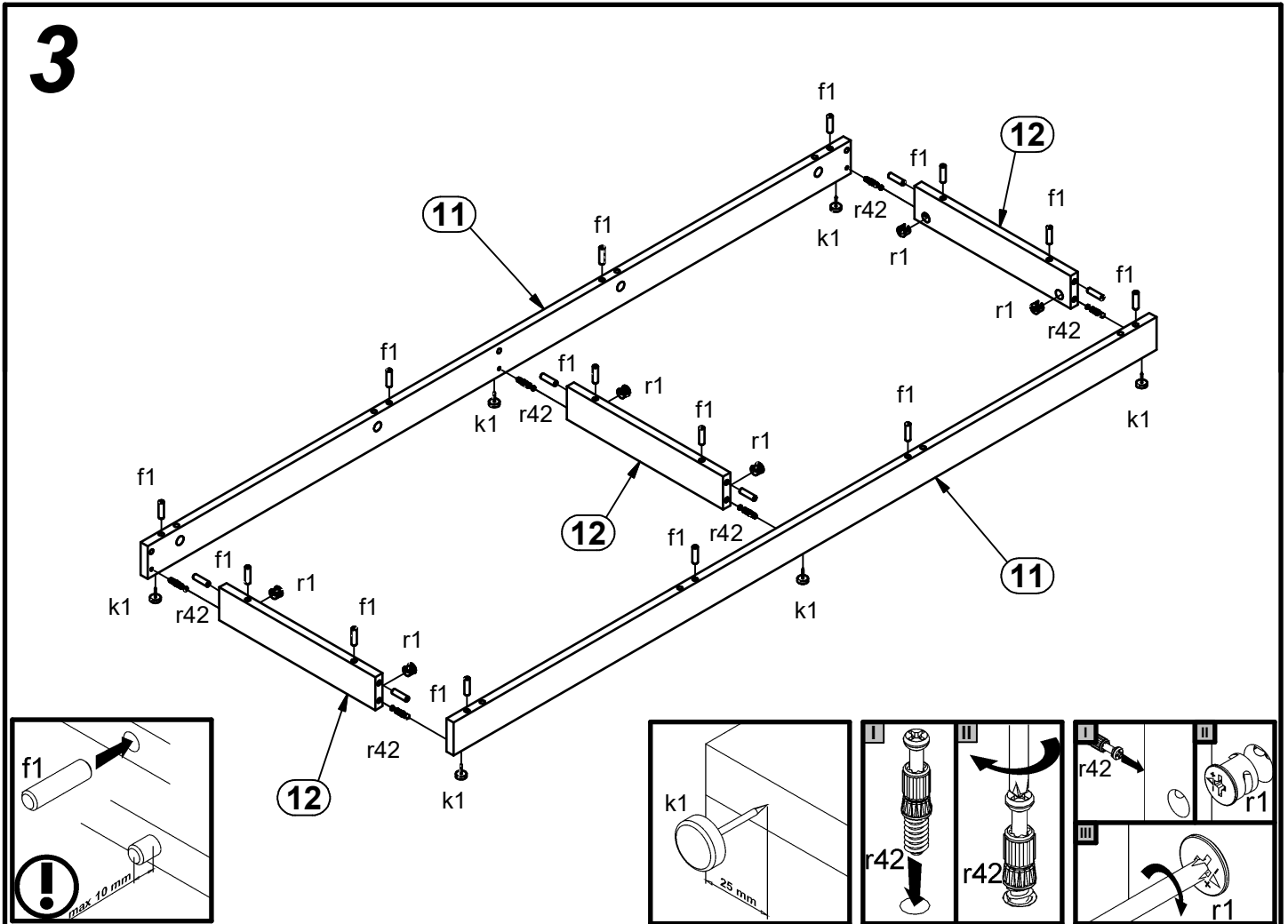

4

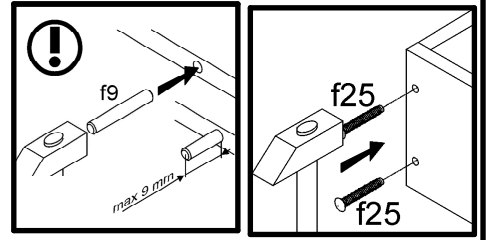
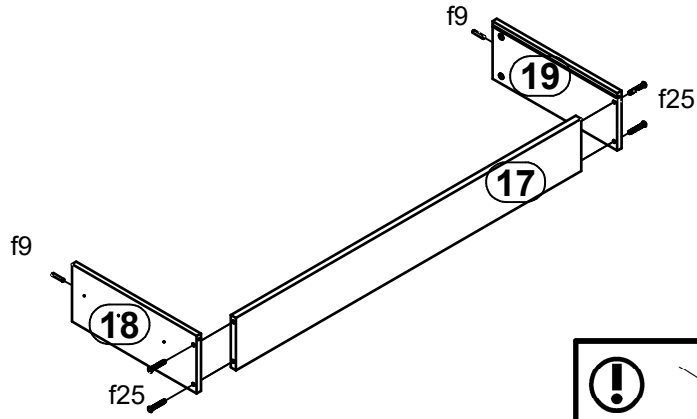

5

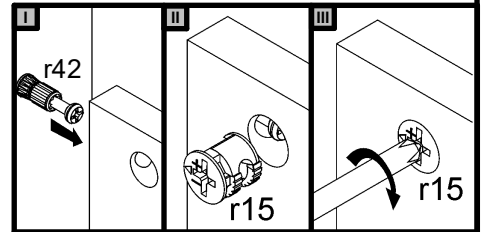
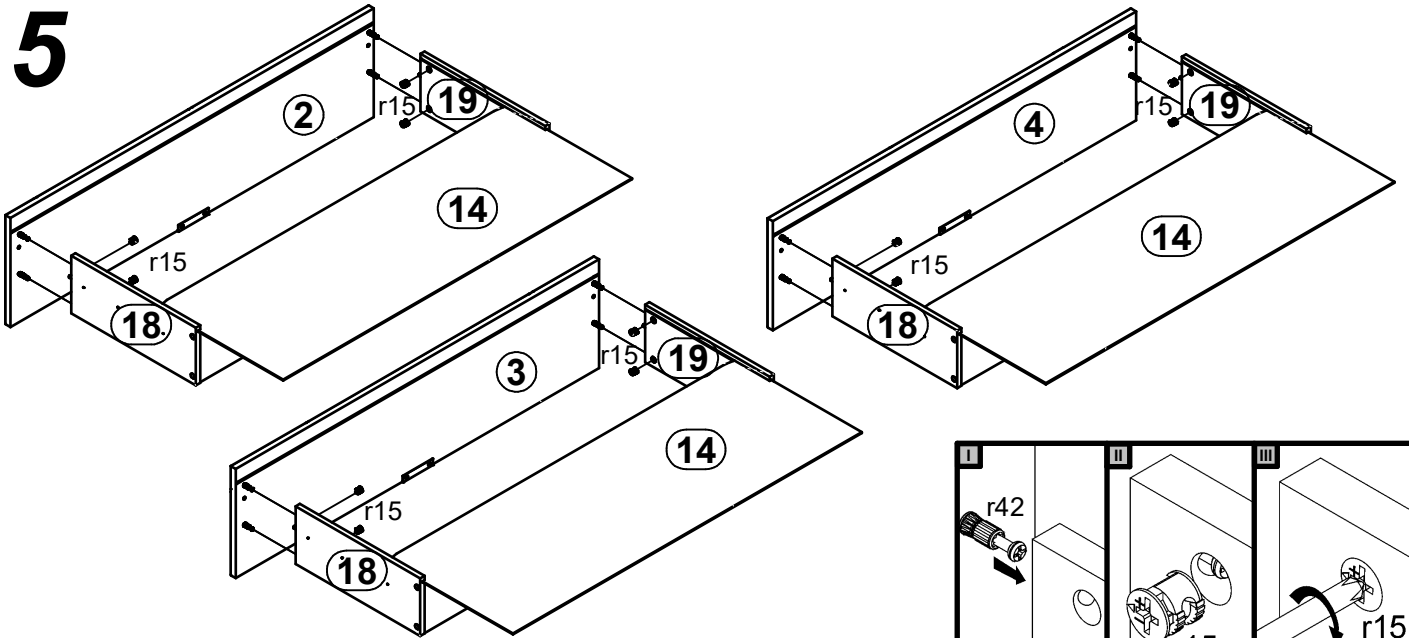

6

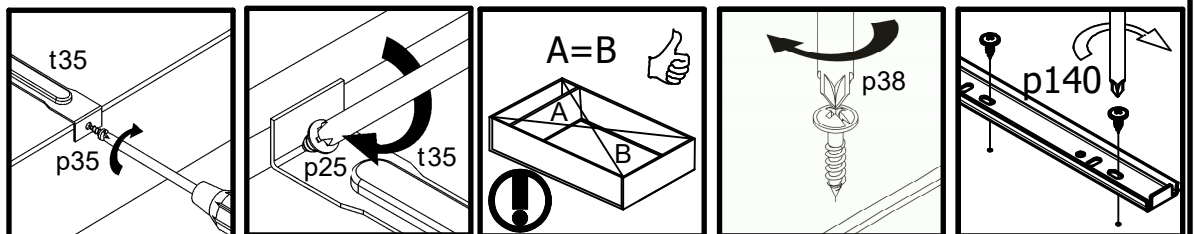
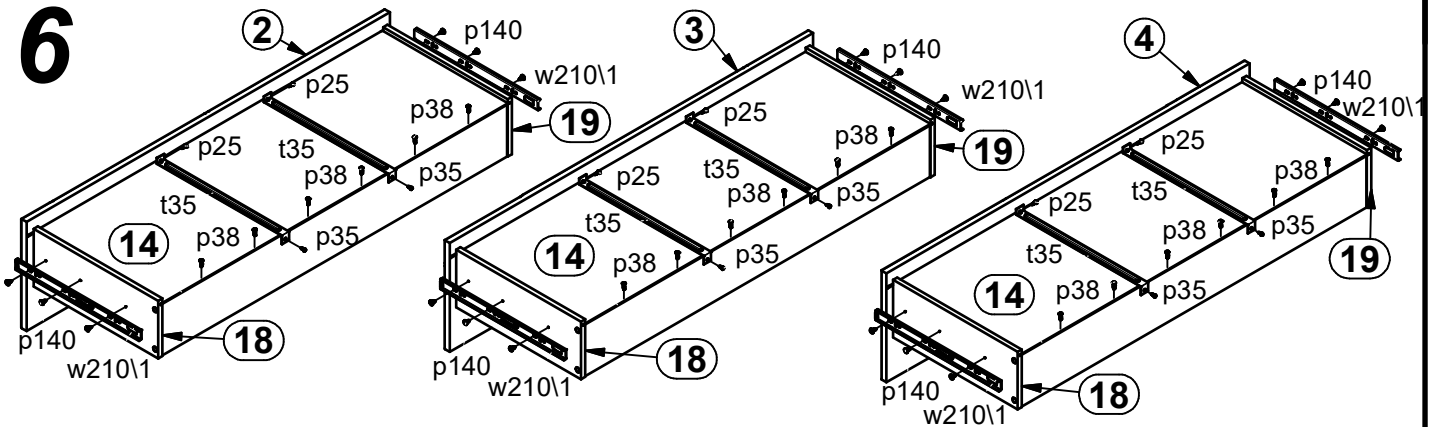

7

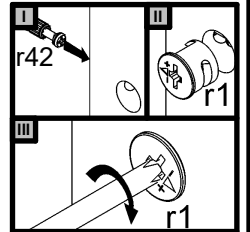
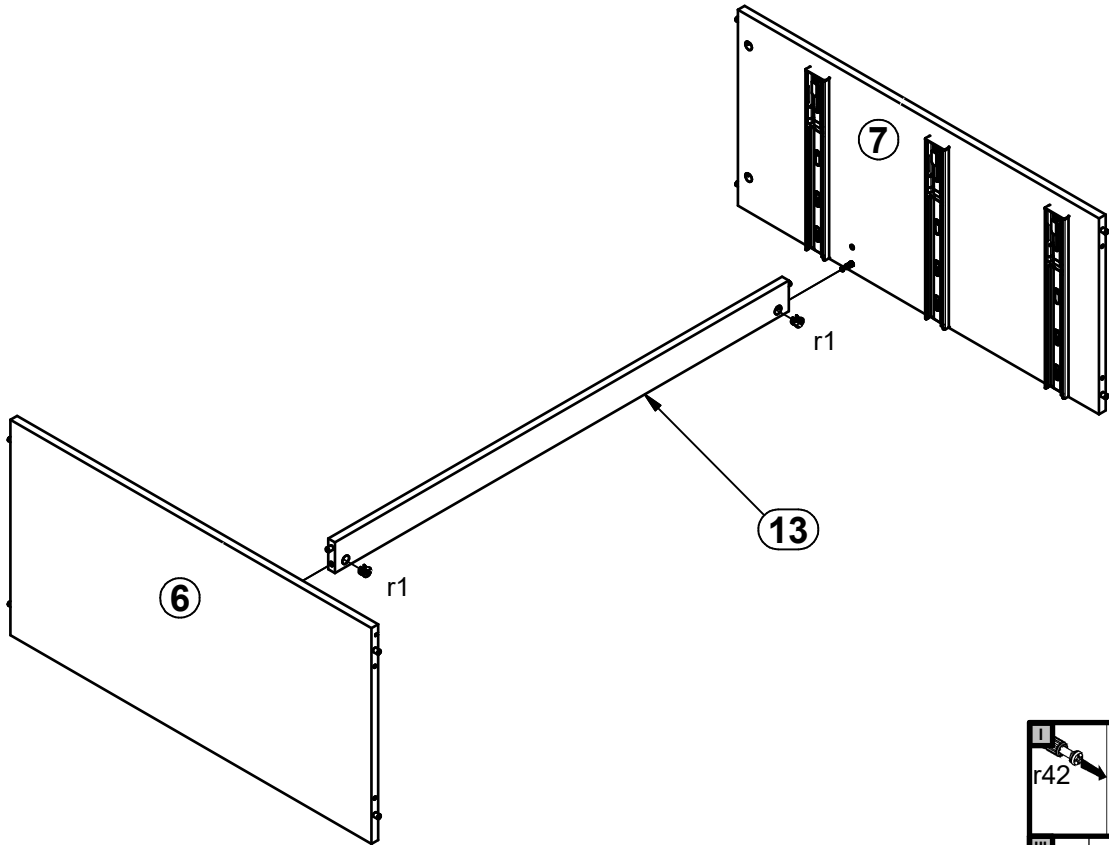

8

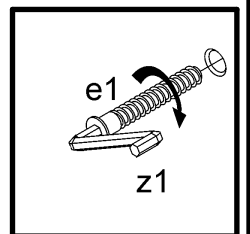
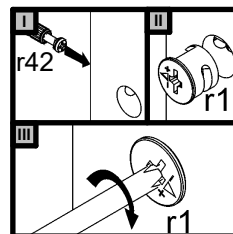
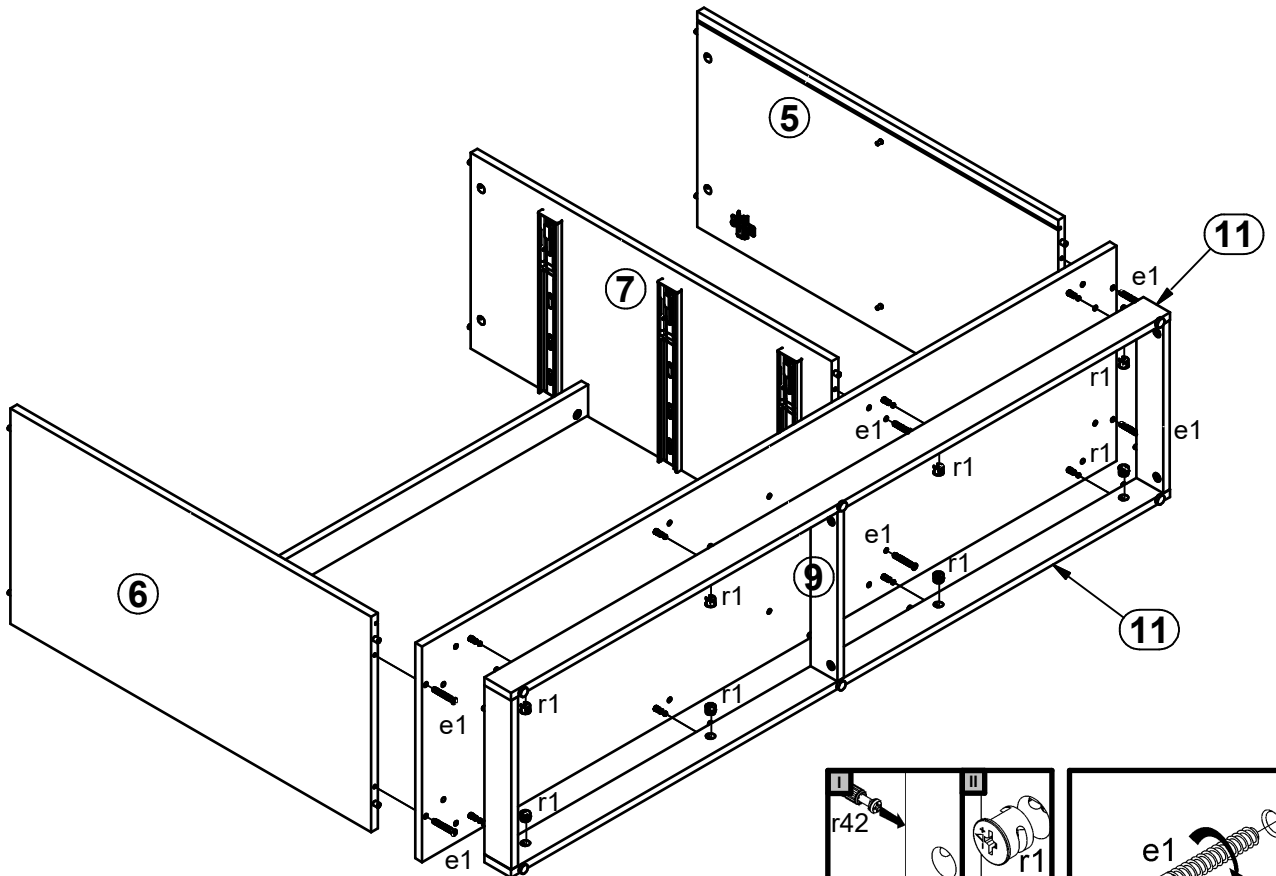

9

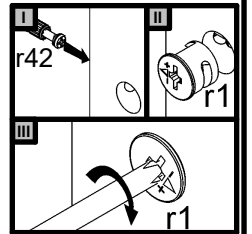
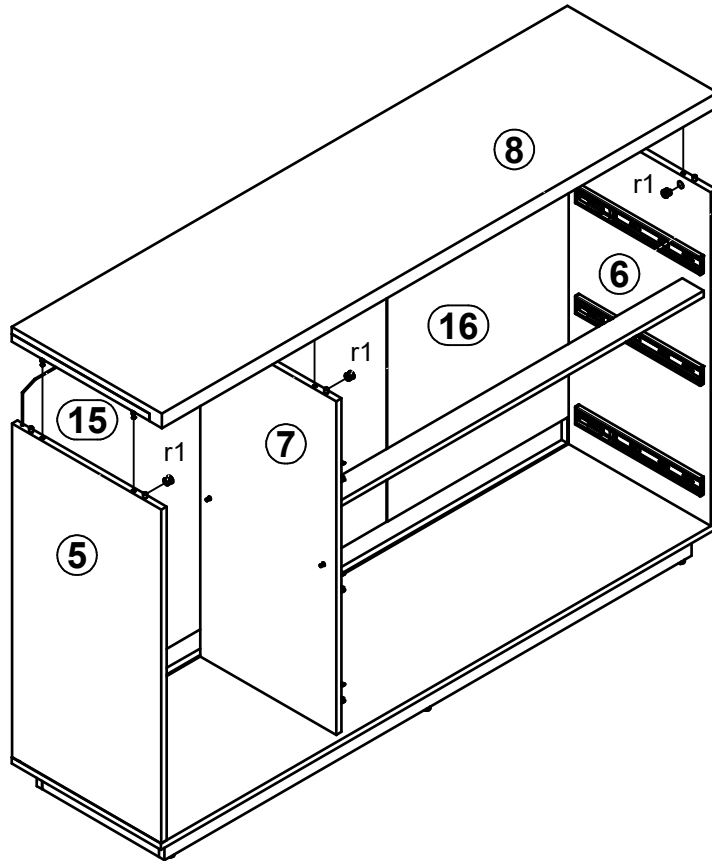

10

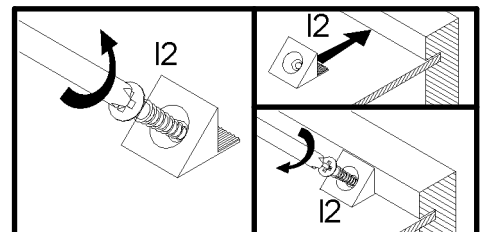
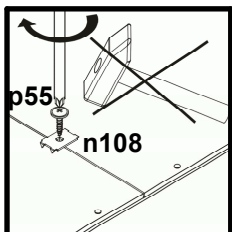
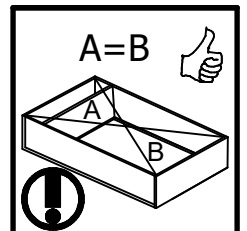
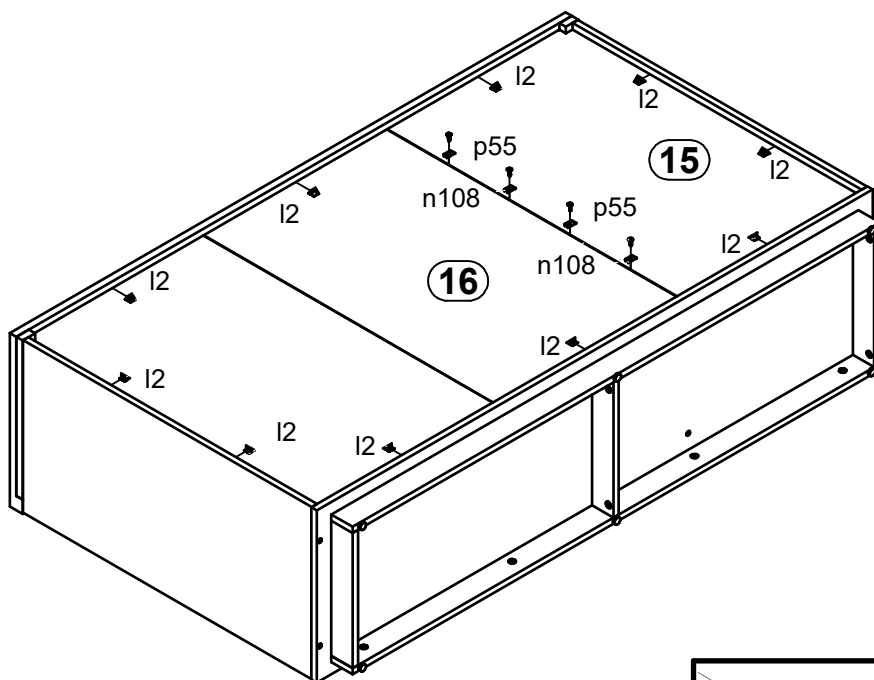

11

