

**SCHOCK**

# SCHOCK **SC-90**

598000

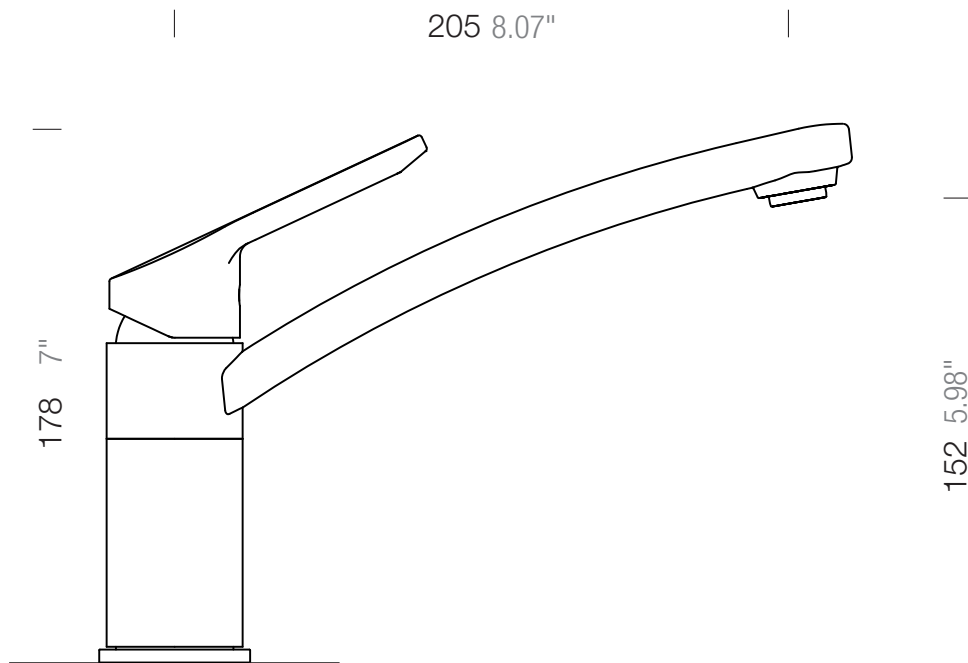

Lochbohrung  $\varnothing$  35

Hole 1.37"