

A	B	C1	C2	C3	D
1	S515-0003	1252	555	19	3/3
2	S515-0004	486	555	19	3/3
3	S515-1004	2000	413	50	2/3
4	S515-1005	2000	413	50	2/3
5	S515-2002	710	438	28	1/3
6	S515-3004	561	373	15	1/3
7	S515-3005	560	362	15	1/3
8	S515-3006	561	372	15	1/3
9	S515-5203	561	50	19	3/3
10	S515-9003	1869	571	2.5	3/3

4x Ø6.3x15 mm d4	3x Ø16 mm o114	1x 6W o60 3 4	
5x K16: 435 a203	5x b91	2x c475	
16x Ø5x17 mm d1	6x d41/2	12x Ø8x30 mm f1	
2x M4x25 mm j8	4x k1	10x l1	
11x l2	24x Ø3.5x16 mm p38	10x Ø3.5x15 mm p51	
12x Ø15x12 mm #16 r1	12x 20/11 r42	4x Ø16 s2	
1x Ø10x50 mm f35	1x Ø5x60 mm p17	2x Ø3.5x16 mm p38	1x 88x21x15/1.5 n14/2

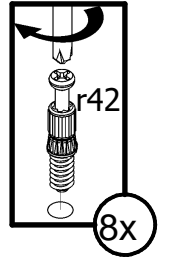

**1** §1

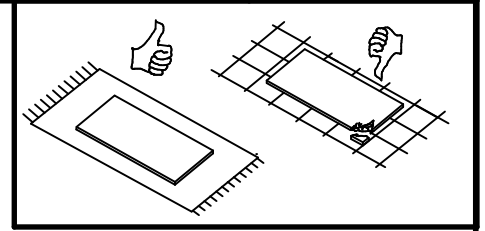
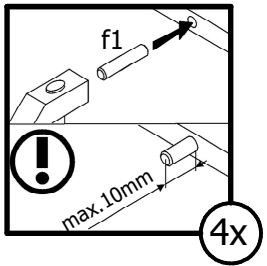
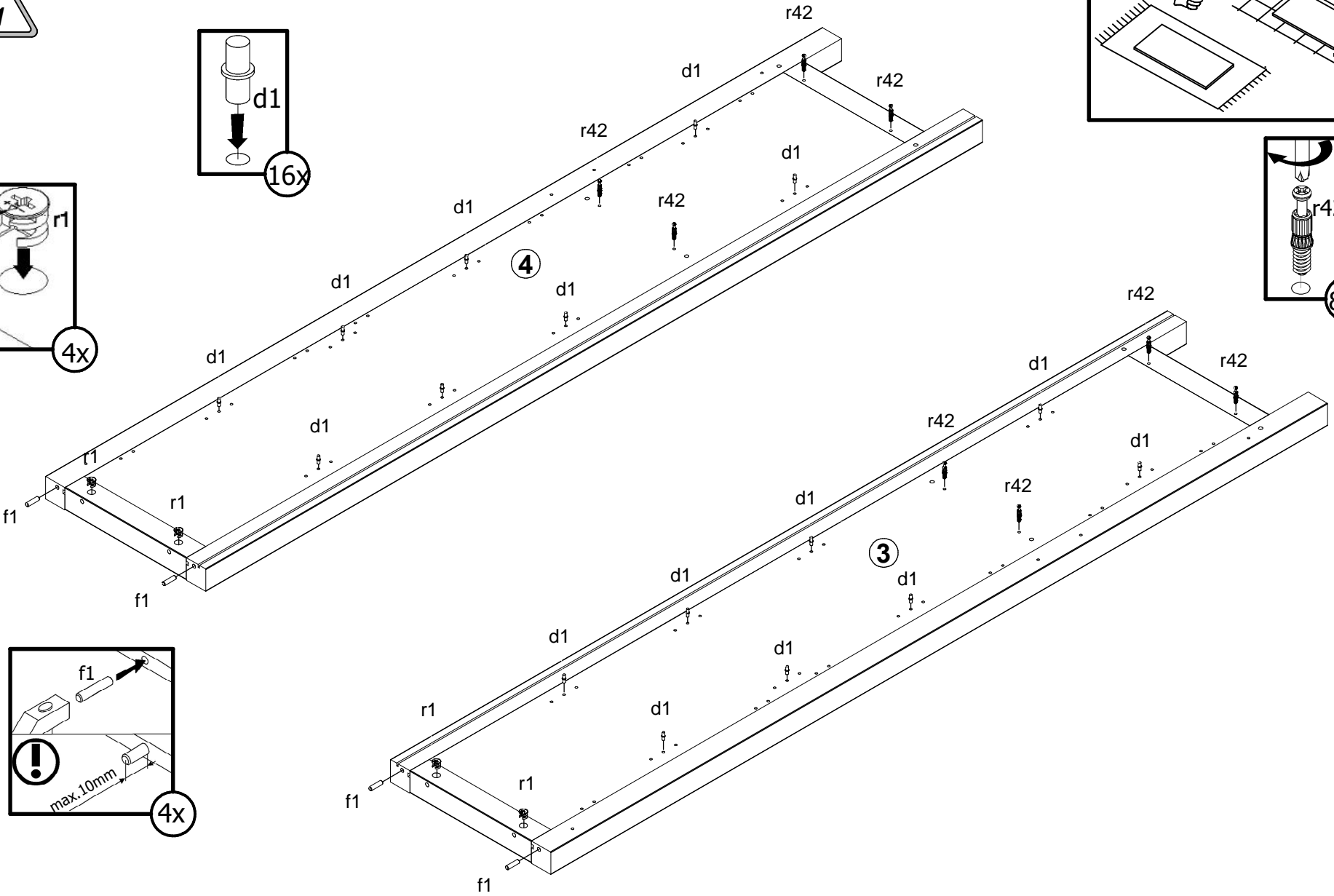
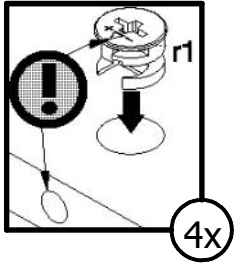
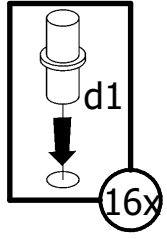

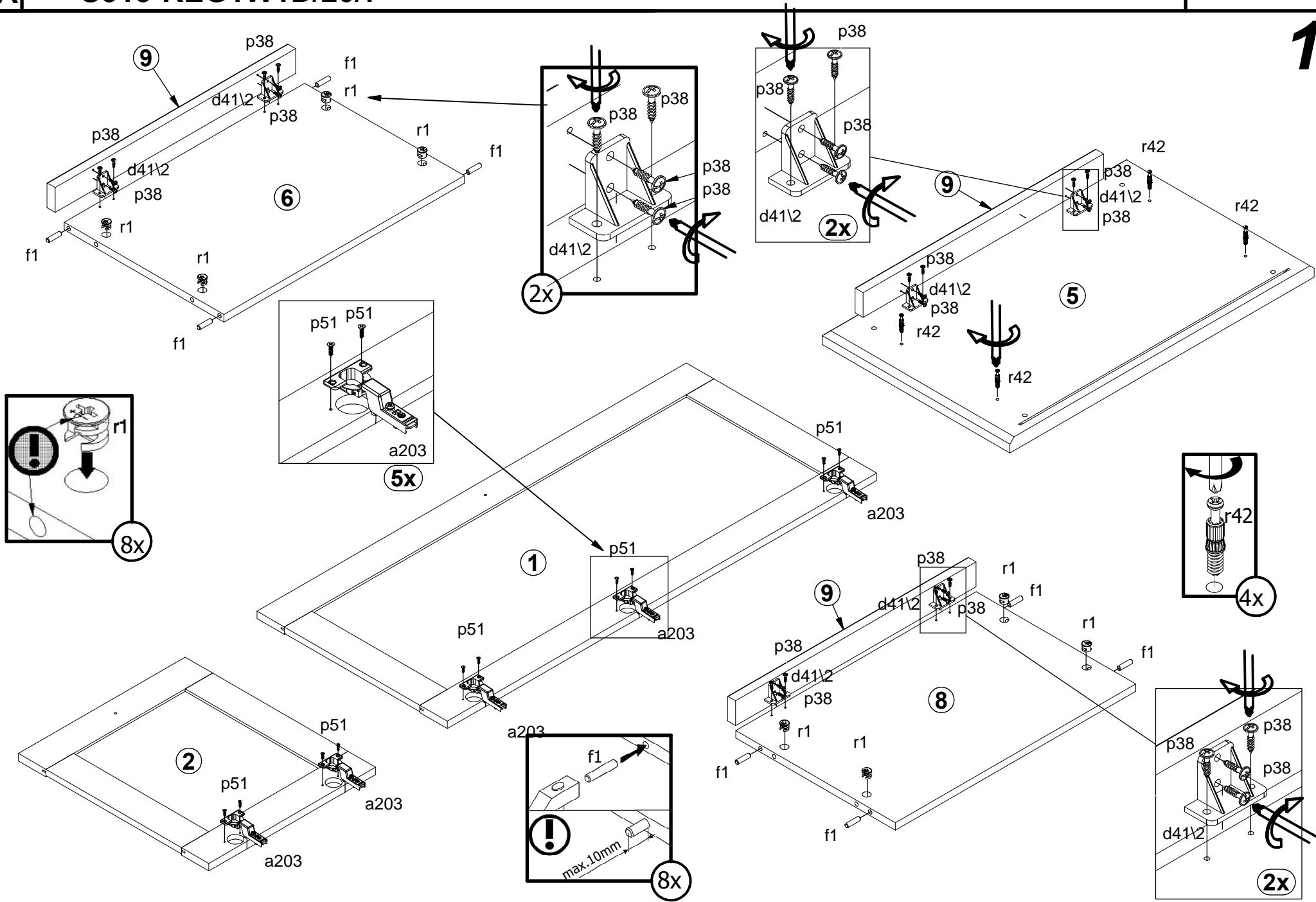

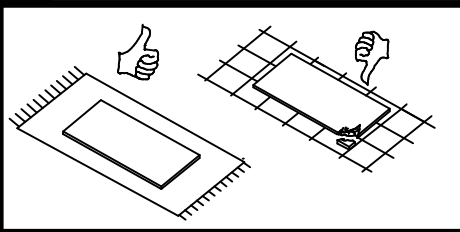

2

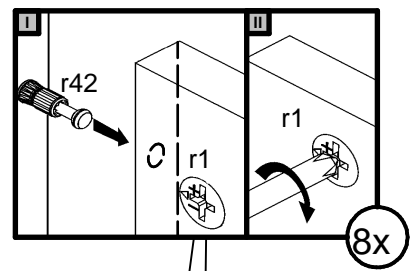
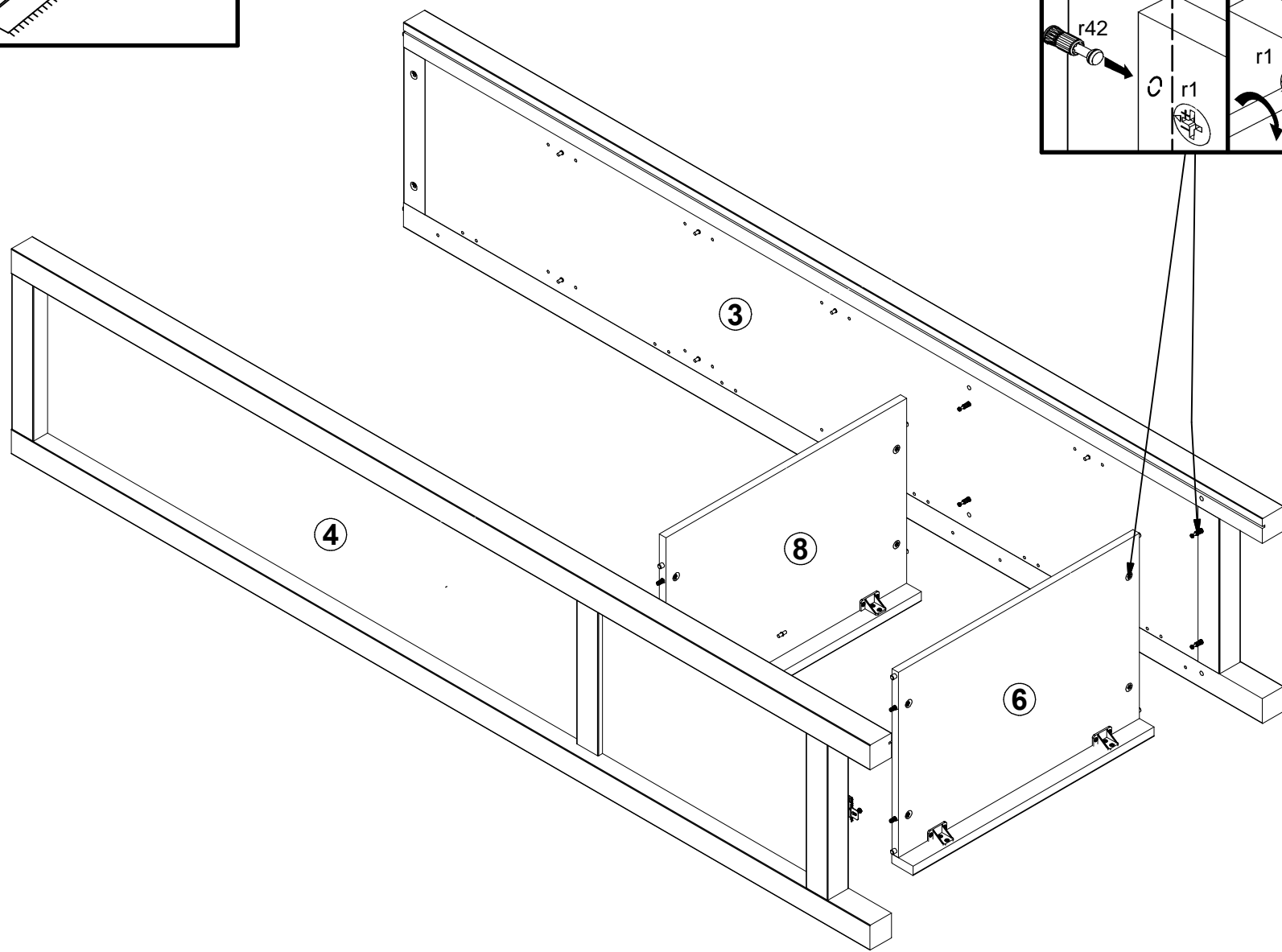

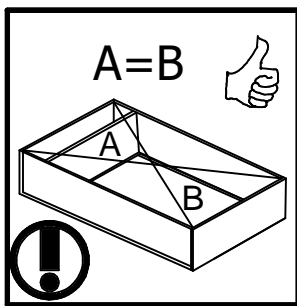

3

4

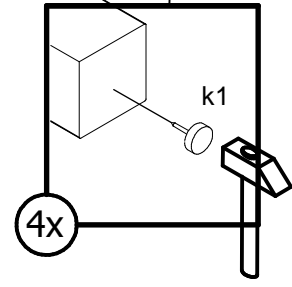
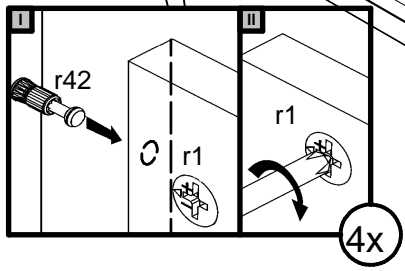
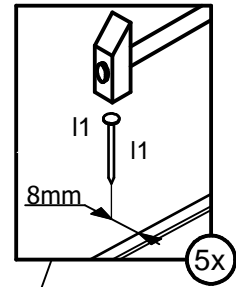
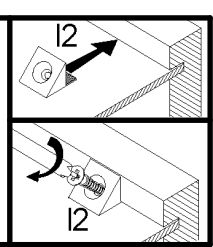
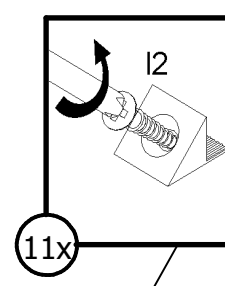
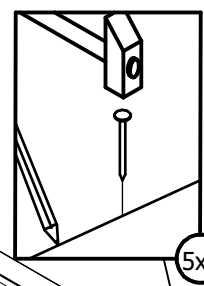
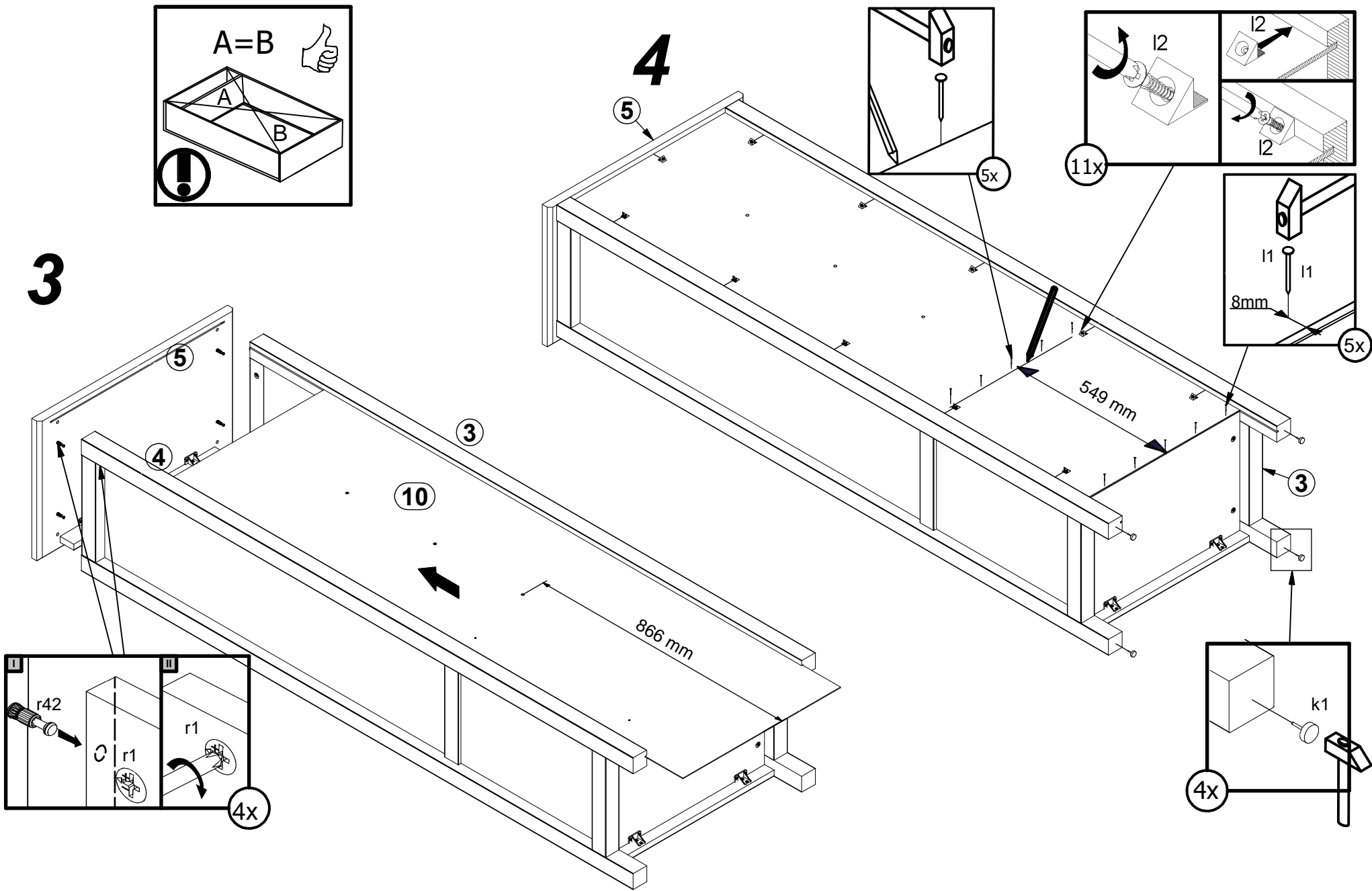

5

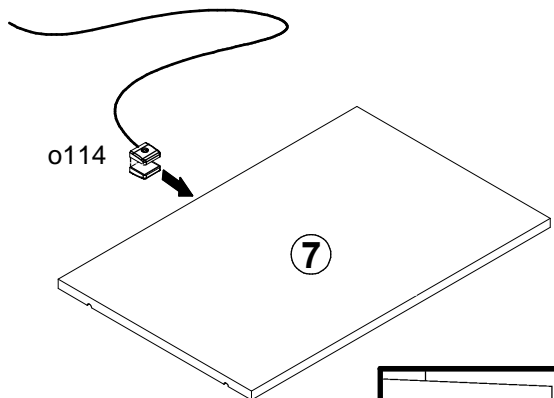
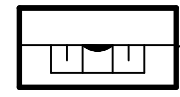
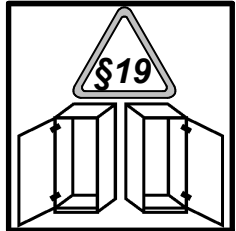

3

5

7

7

7

7

7

4

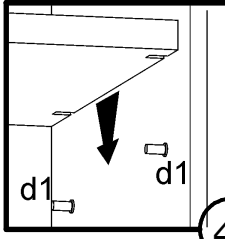
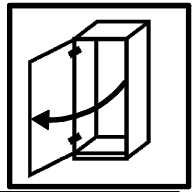
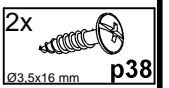
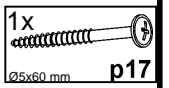
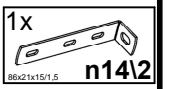
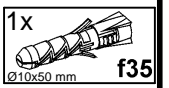
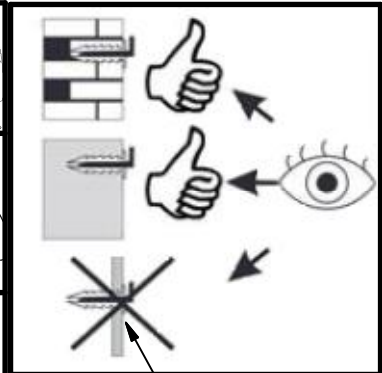
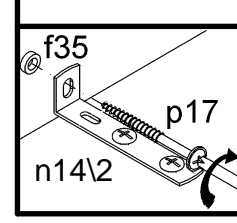
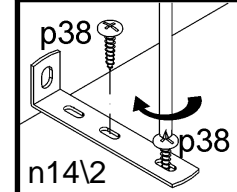
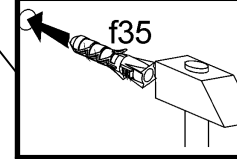
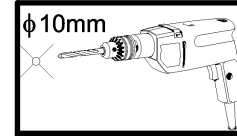

4x

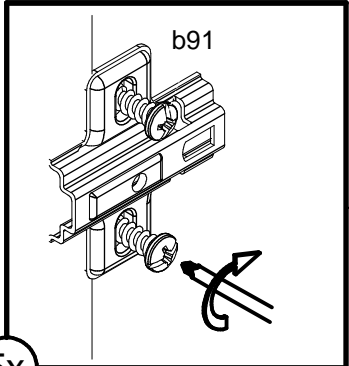

5x

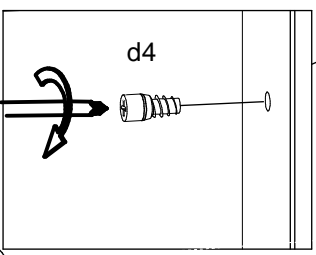

4x

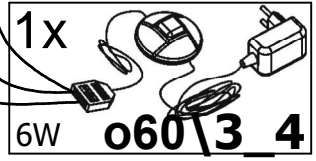

4x

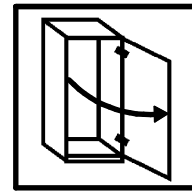

5x

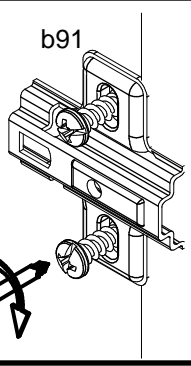

b91

d4

d4

d4

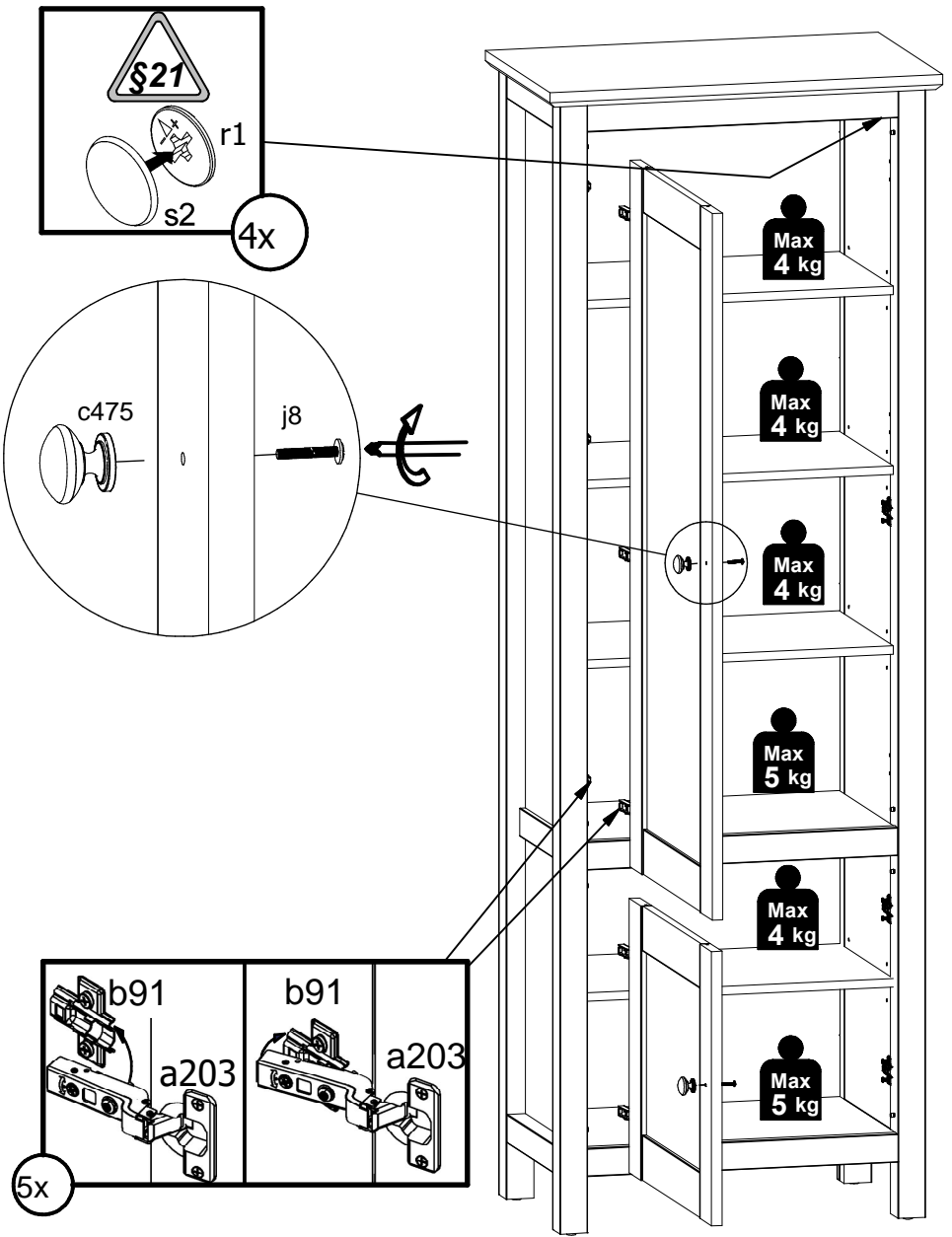

6

