

A	B	C (mm)		D
1	S228-020	1845	438	4/4
2	S228-021	1845	438	4/4
3	S228-142	2009	540	1/4
4	S228-143	2009	540	1/4
5	S228-144	1915,5	520	1/4
6	S228-217	1456	540	2/4
7	S228-334	1424	520	2/4
8	S228-335	928	517	2/4
9	S228-336	479	515	2/4
10	S228-337	480	520	2/4
11	S228-531	147	100	2/4
12	S228-5581	540	80	2/4
13	S228-5582	2015	58	3/4
14	S228-5583	424	80	2/4
15	S228-5584	2005	58	3/4
16	S228-5585	1501	80	3/4
17	S228-5586	1340	80	3/4
18	S228-5587	926	40	2/4
19	S228-5588	2005	80	3/4
20	S228-5589	2005	80	3/4
21	S228-5590	478	40	2/4
22	S228-583	1833	29	4/4
23	S228-910	1935	494	1/4
24	S228-9910	1935	941	1/4
25	dr-924	924	30	2/4

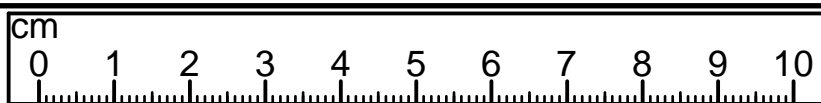

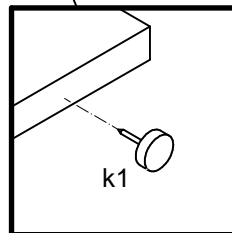

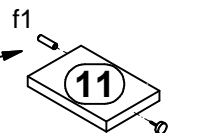

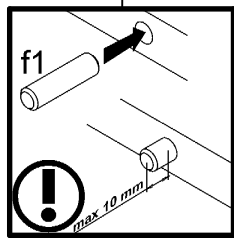
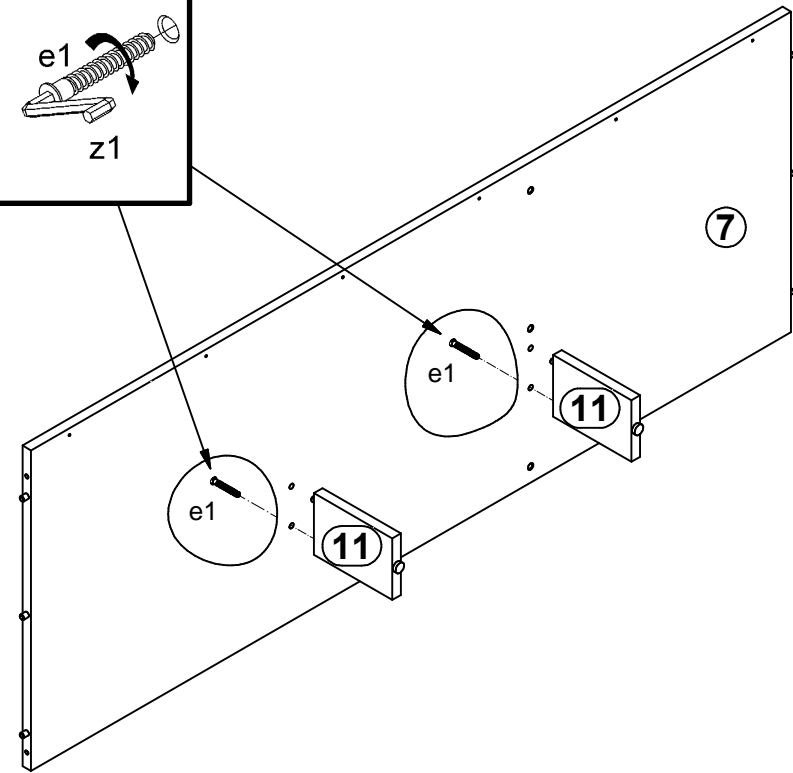
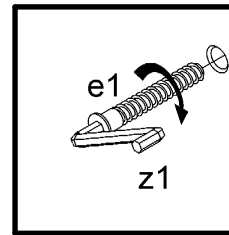
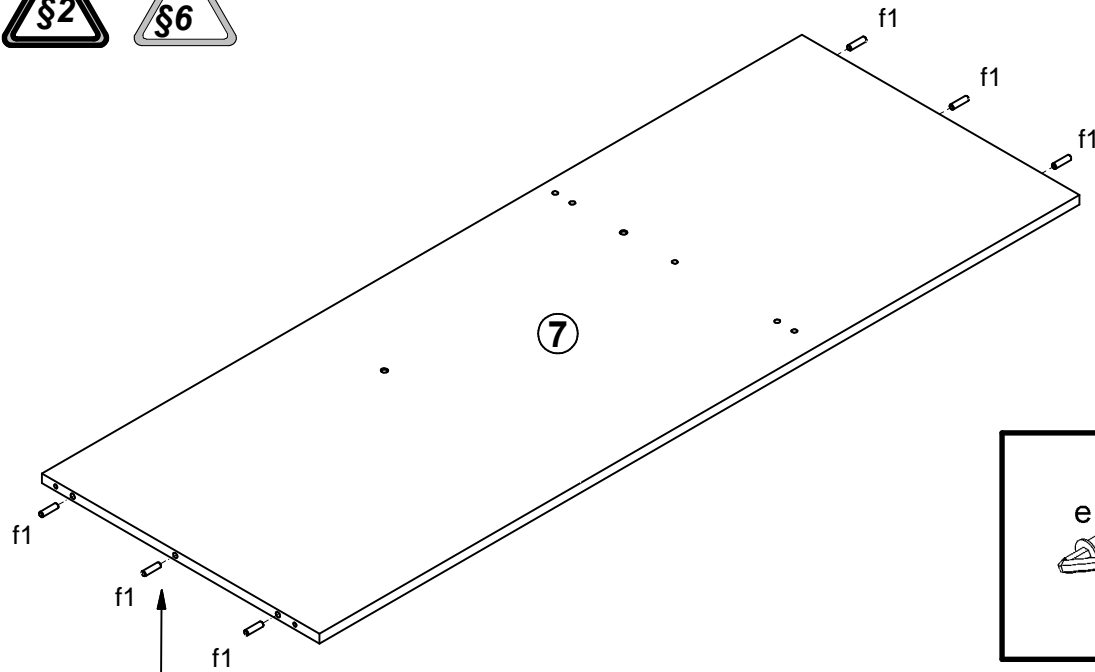

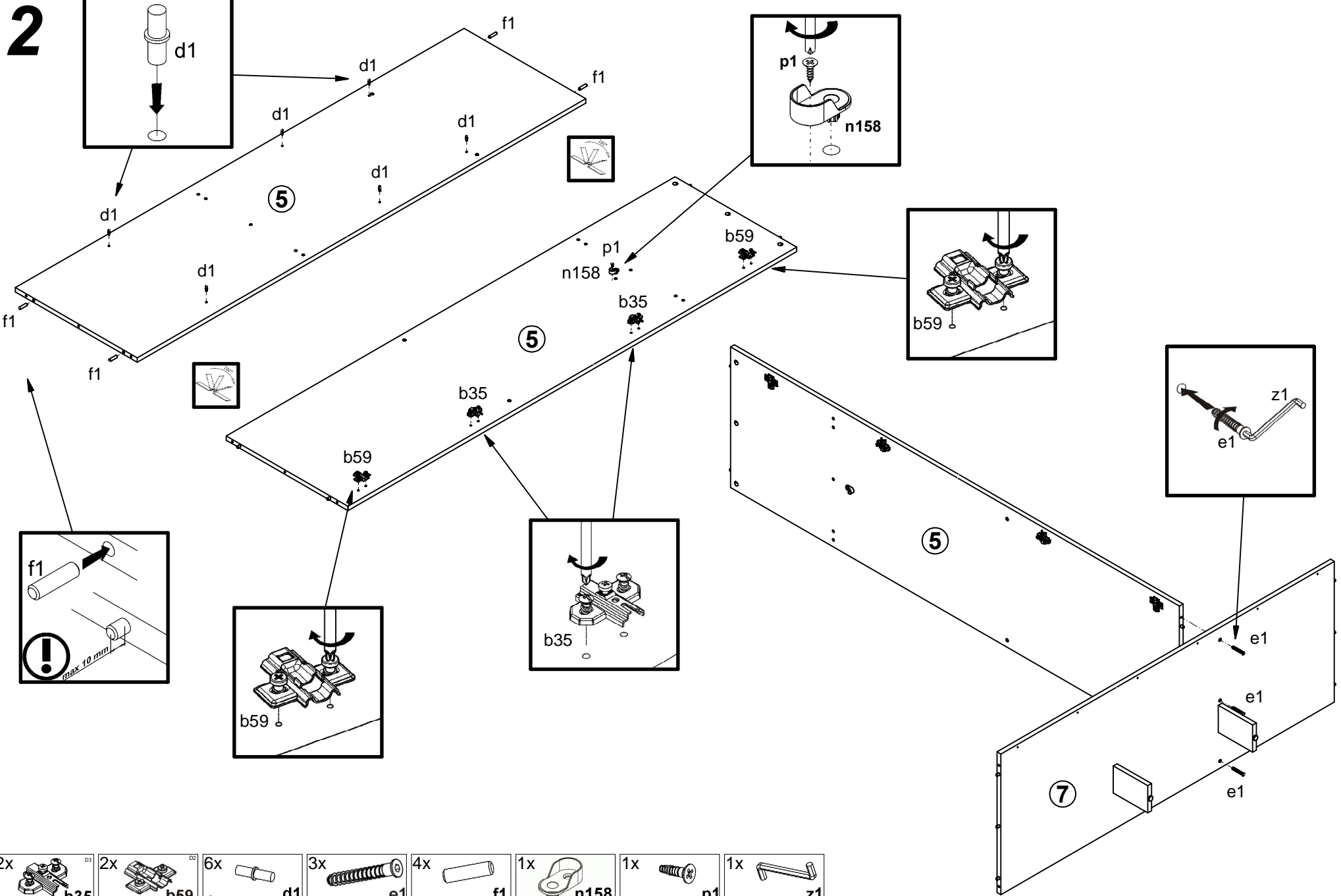

2x K91_495  <b>a103</b>	8x  <b>a132</b>	4x  <b>a133</b>	2x K91_5  <b>a68</b>	2x  <b>b35</b>	8x  <b>b43</b>	2x  <b>b59</b>	3x  <b>c280\1</b>	12x  <b>d1</b>	6x  <b>d36</b>	17x  <b>e1</b>	16x  <b>e2</b>	24x  <b>e22</b>
40x  <b>f1</b>	16x  <b>f13</b>	1x  <b>f35</b>	6x  <b>j30</b>	8x  <b>k1</b>	2x  <b>k101</b>	30x  <b>l1</b>	18x  <b>l2</b>	1x  <b>n14\2</b>	10x  <b>n108</b>	2x  <b>n158</b>	2x  <b>p1</b>	1x  <b>p17</b>
11x  <b>p38</b>	36x  <b>p51</b>	10x  <b>p55</b>	4x  <b>p79</b>	6x  <b>p8</b>	25x  <b>r1</b>	25x  <b>r42</b>	20x  <b>s1</b>	17x  <b>s2</b>	1x  <b>z1</b>			



- 2x e1 Ø7x50 mm
- 8x f1 Ø8x30 mm
- 2x k1
- 1x z1



- |                                                                                                   |                                                                                                   |                                                                                                              |                                                                                                              |                                                                                                              |                                                                                                     |                                                                                                                  |                                                                                                    |
|---------------------------------------------------------------------------------------------------|---------------------------------------------------------------------------------------------------|--------------------------------------------------------------------------------------------------------------|--------------------------------------------------------------------------------------------------------------|--------------------------------------------------------------------------------------------------------------|-----------------------------------------------------------------------------------------------------|------------------------------------------------------------------------------------------------------------------|----------------------------------------------------------------------------------------------------|
| 2x  <b>b35</b> | 2x  <b>b59</b> | 6x  <b>d1</b><br>Ø5x17 mm | 3x  <b>e1</b><br>Ø7x50 mm | 4x  <b>f1</b><br>Ø8x30 mm | 1x  <b>n158</b> | 1x  <b>p1</b><br>Ø3.5x13 mm | 1x  <b>z1</b> |
|---------------------------------------------------------------------------------------------------|---------------------------------------------------------------------------------------------------|--------------------------------------------------------------------------------------------------------------|--------------------------------------------------------------------------------------------------------------|--------------------------------------------------------------------------------------------------------------|-----------------------------------------------------------------------------------------------------|------------------------------------------------------------------------------------------------------------------|----------------------------------------------------------------------------------------------------|

3

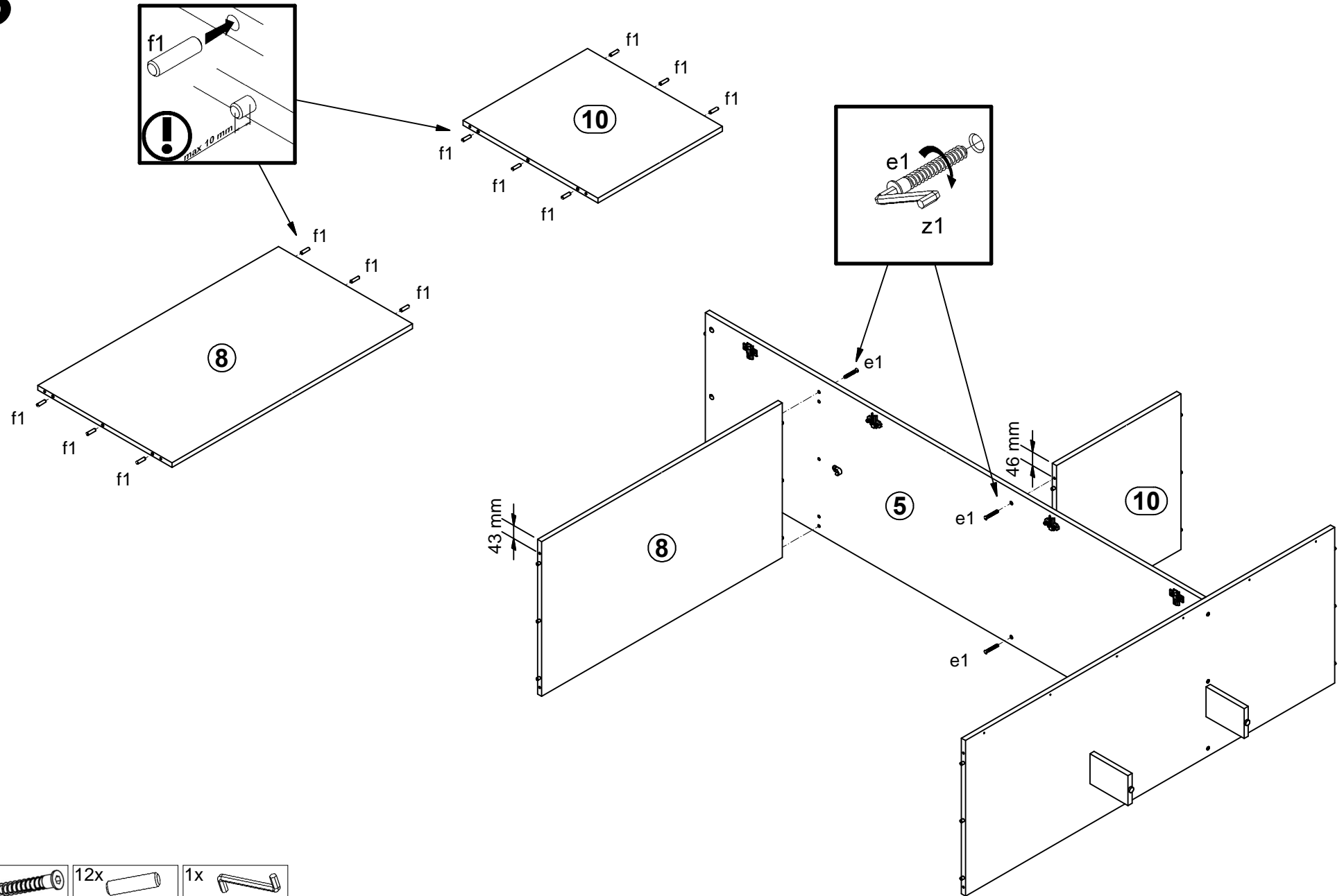

- 4x e1  $\varnothing 7 \times 50 \text{ mm}$
- 12x f1  $\varnothing 8 \times 30 \text{ mm}$
- 1x z1

4

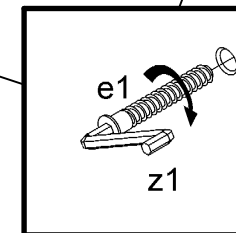
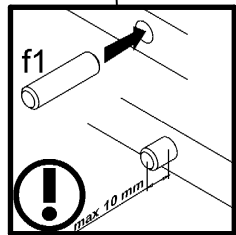
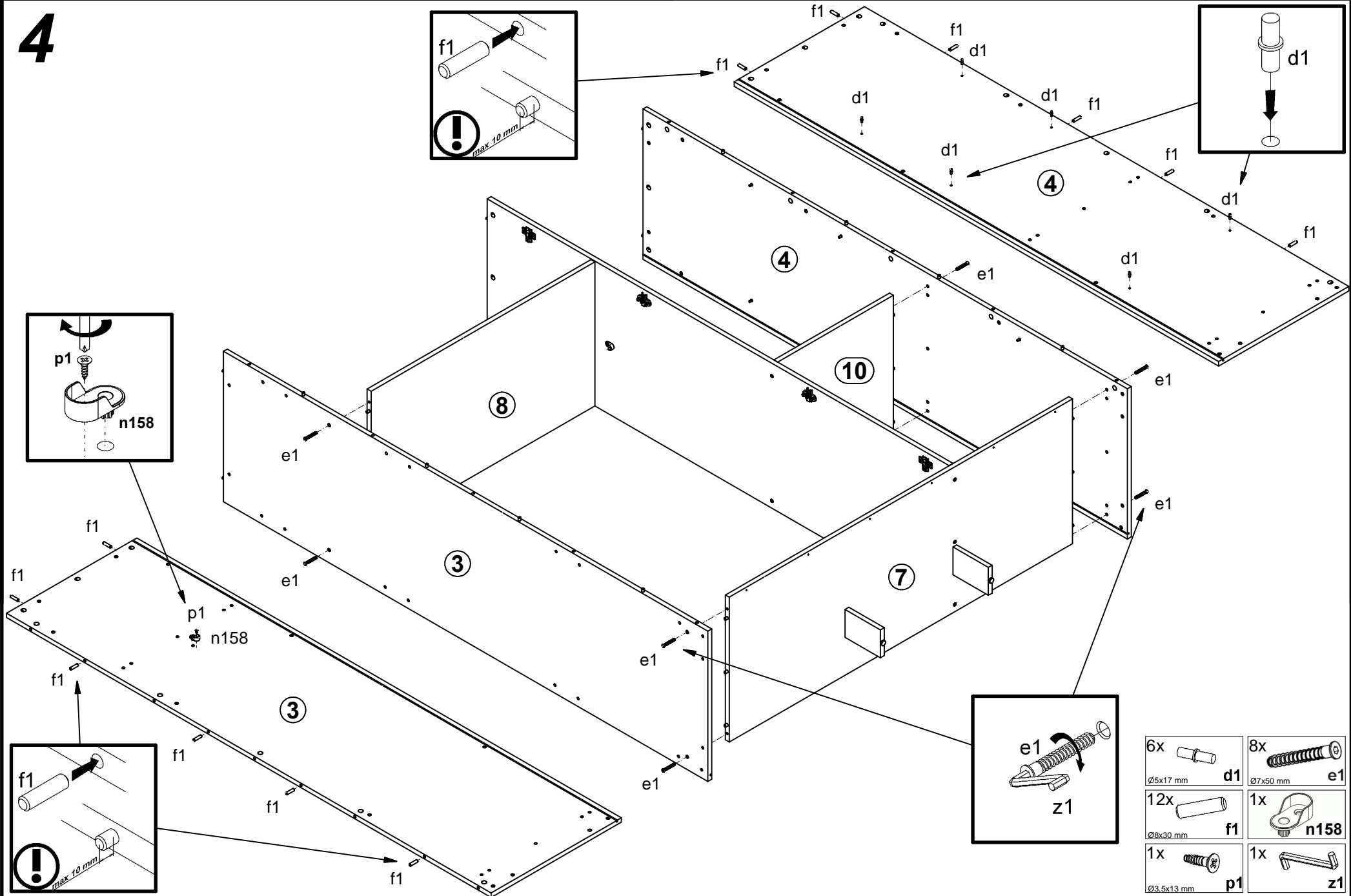
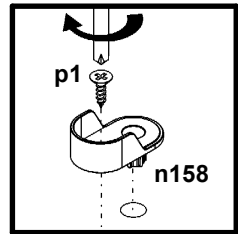
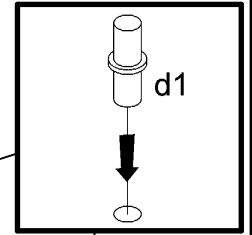
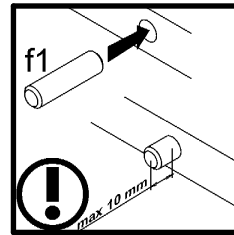

6x Ø5x17 mm d1	8x Ø7x50 mm e1
12x Ø8x30 mm f1	1x n158
1x Ø3.5x13 mm p1	1x z1

# 5

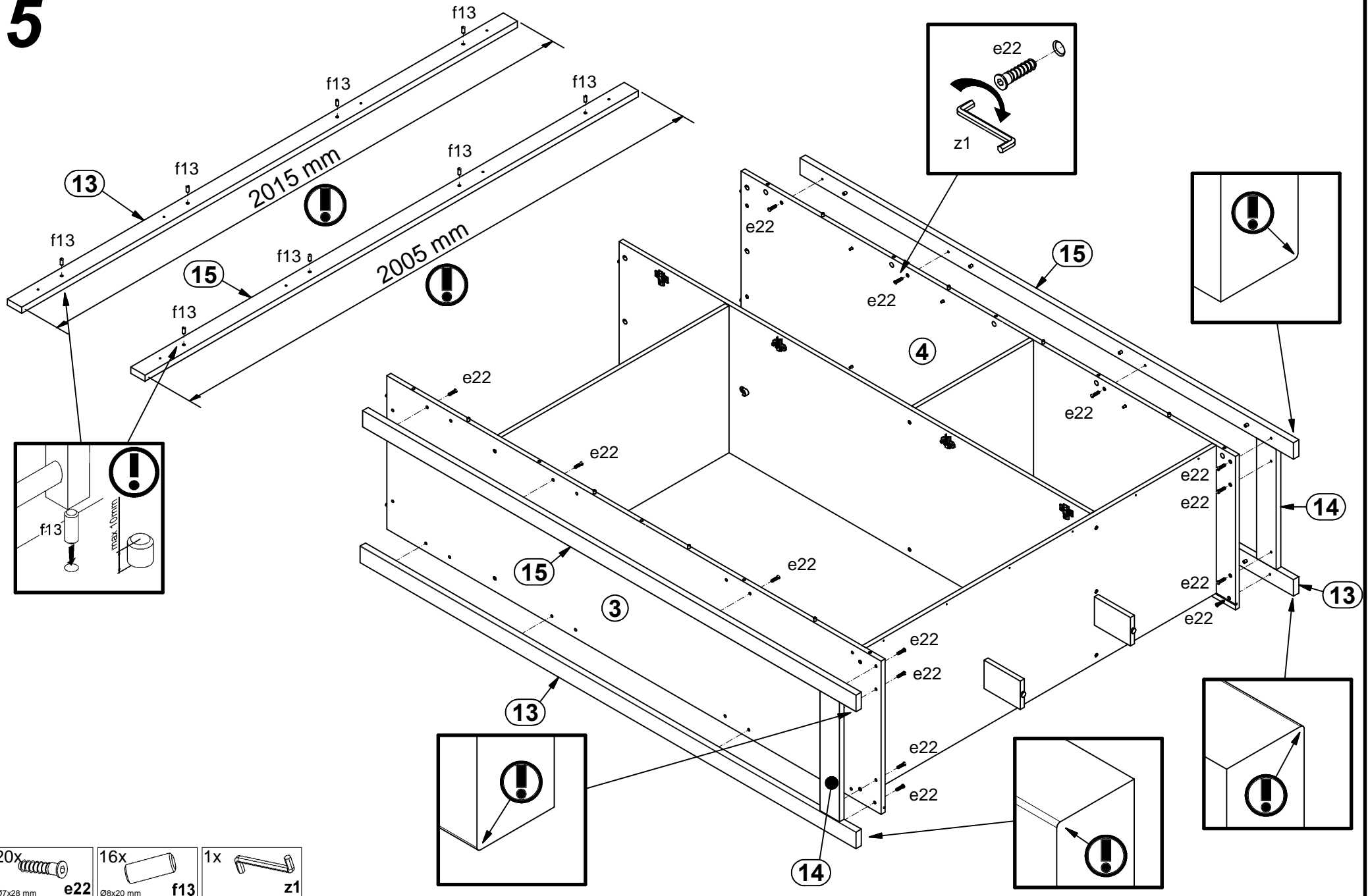

- 20x e22 Ø7x28 mm
- 16x f13 Ø8x20 mm
- 1x z1

# 6

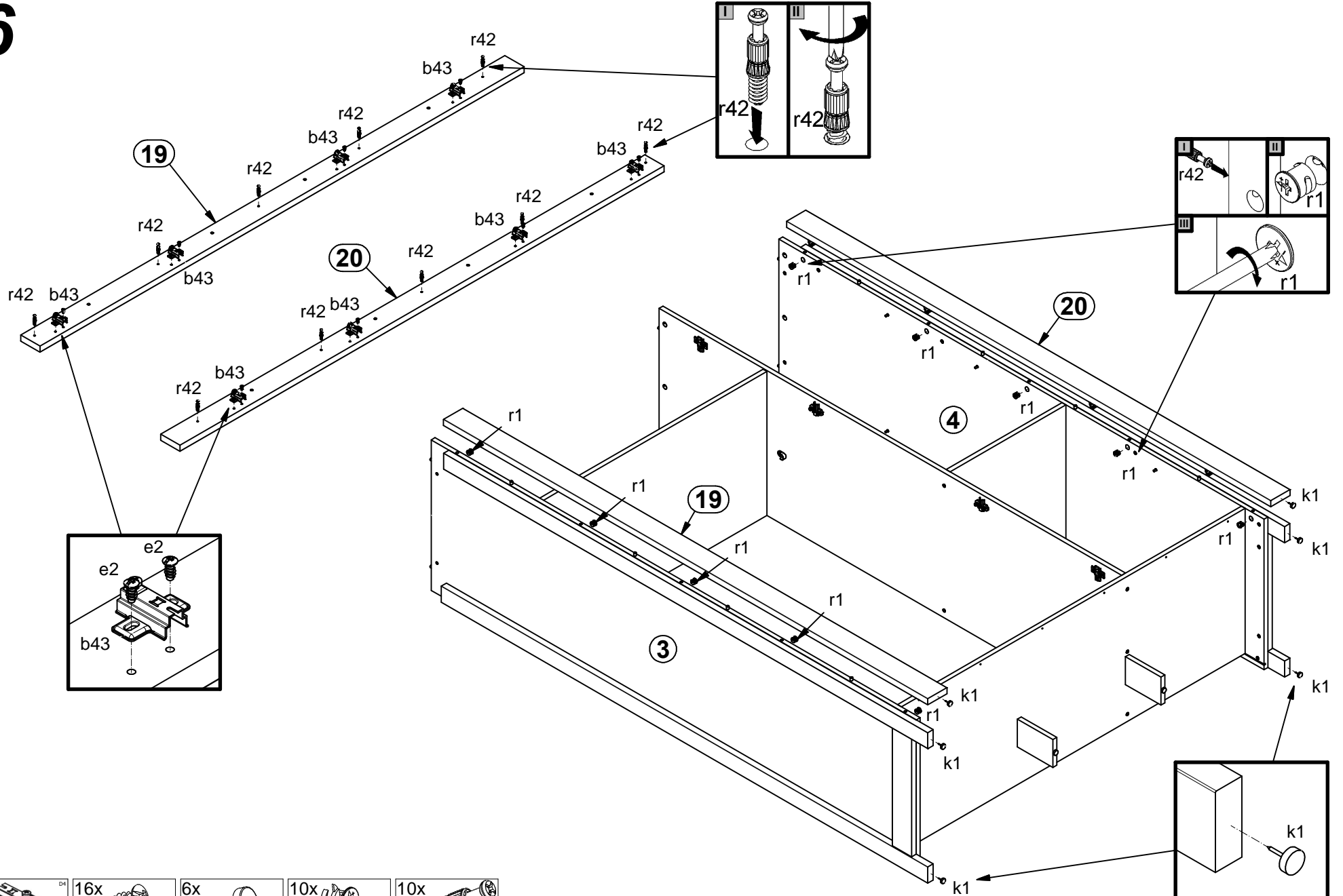

- 8x b43
- 16x e2  
Ø6.3x13 mm
- 6x k1
- 10x r1  
Ø15x12 mm #16
- 10x r42  
20/11



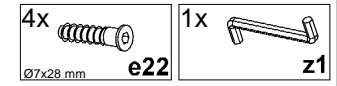
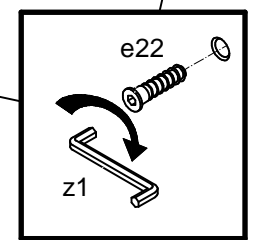
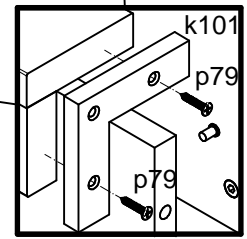
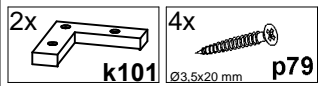
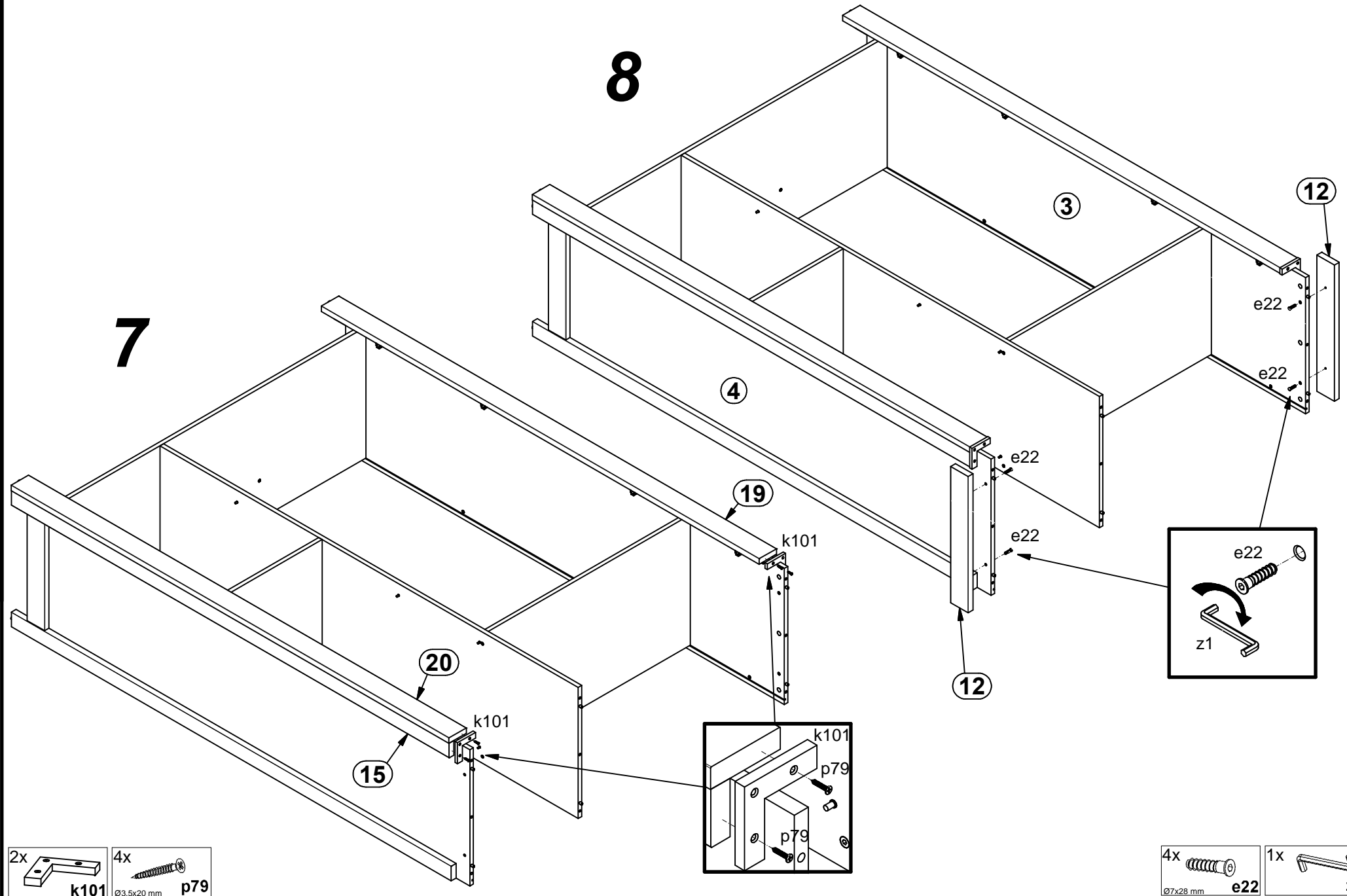

9

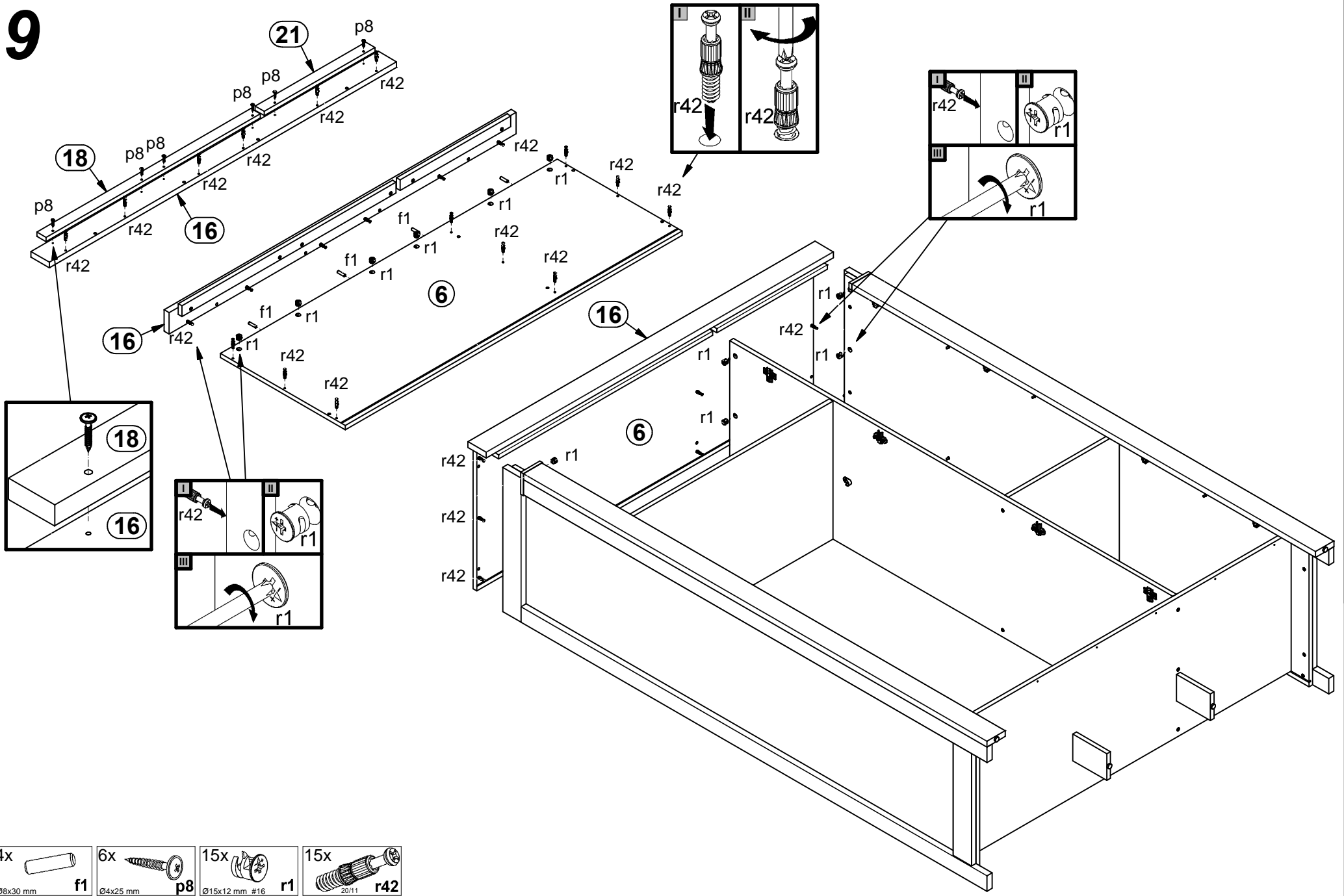

- 4x f1
- 6x p8
- 15x r1
- 15x r42

10

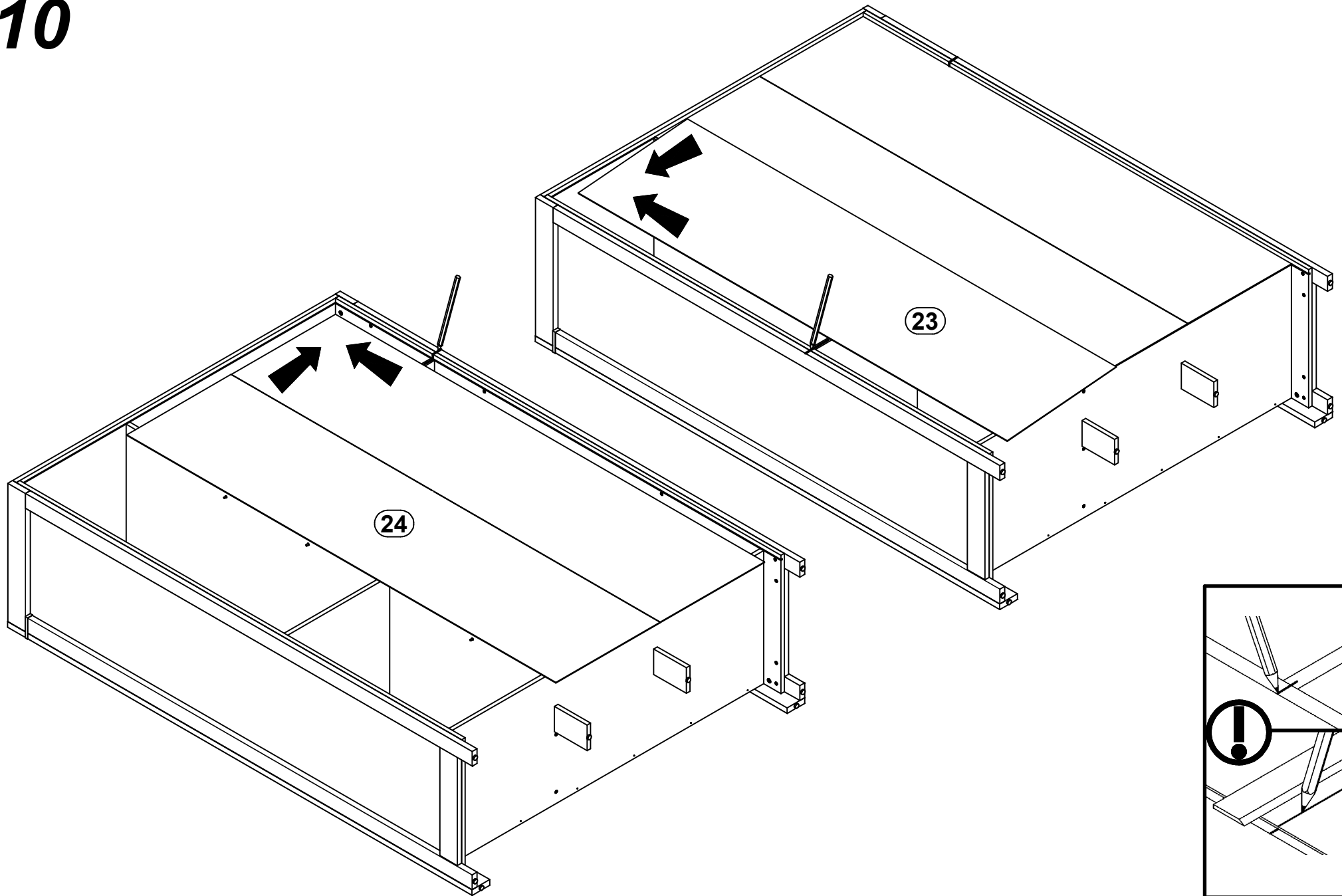



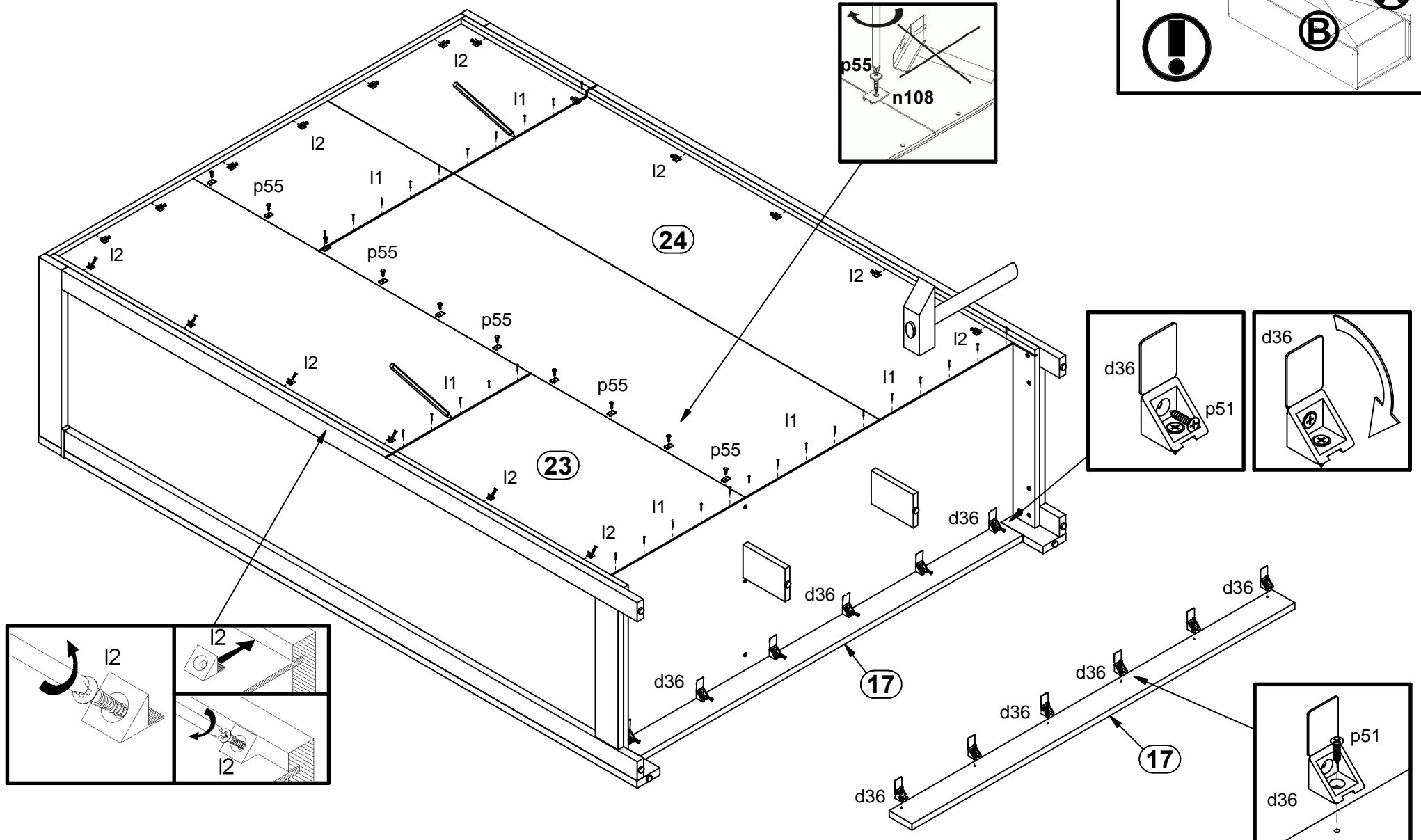
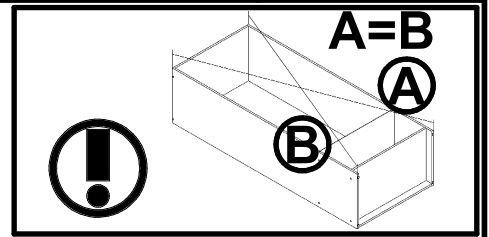



# 11

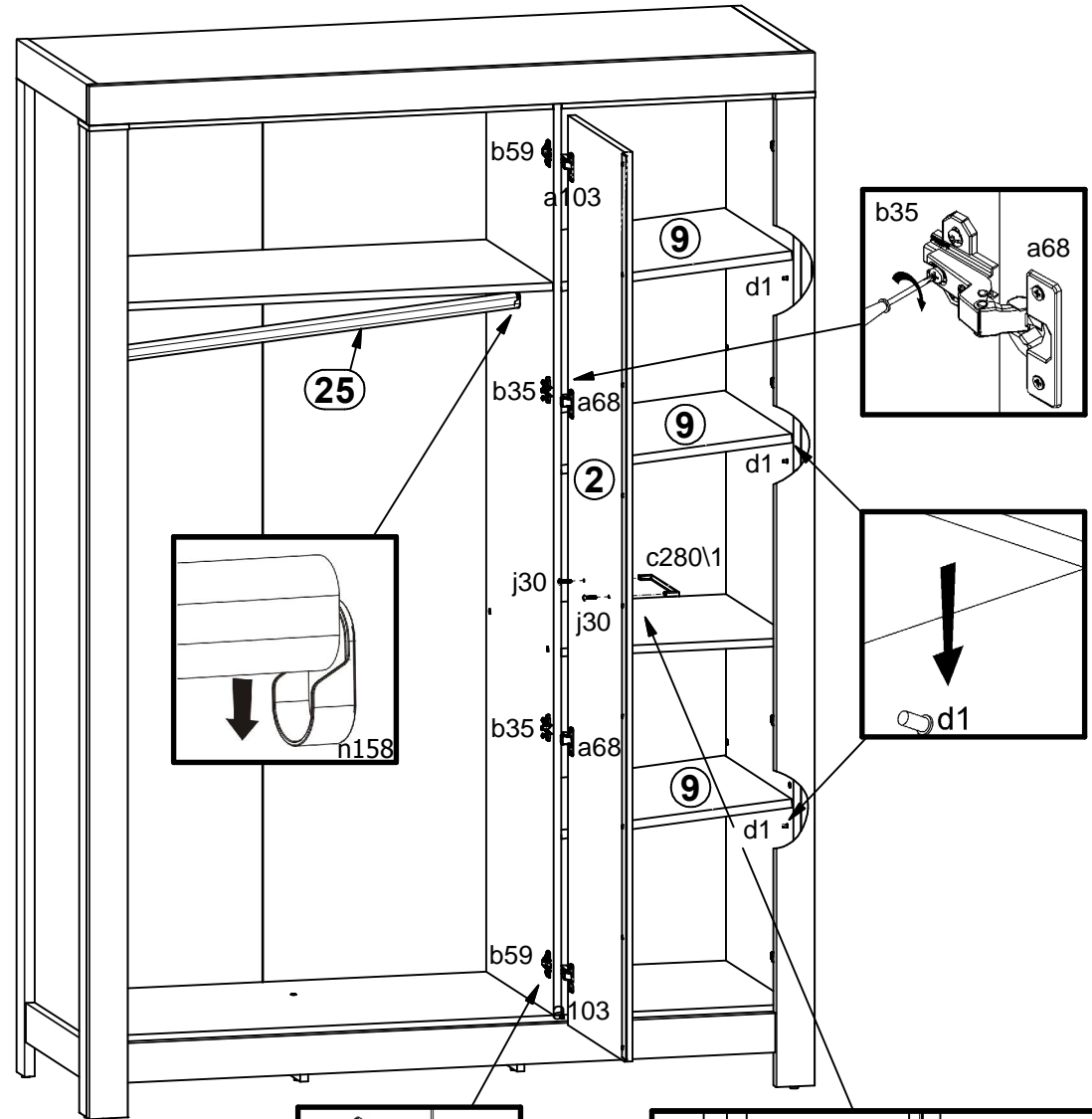
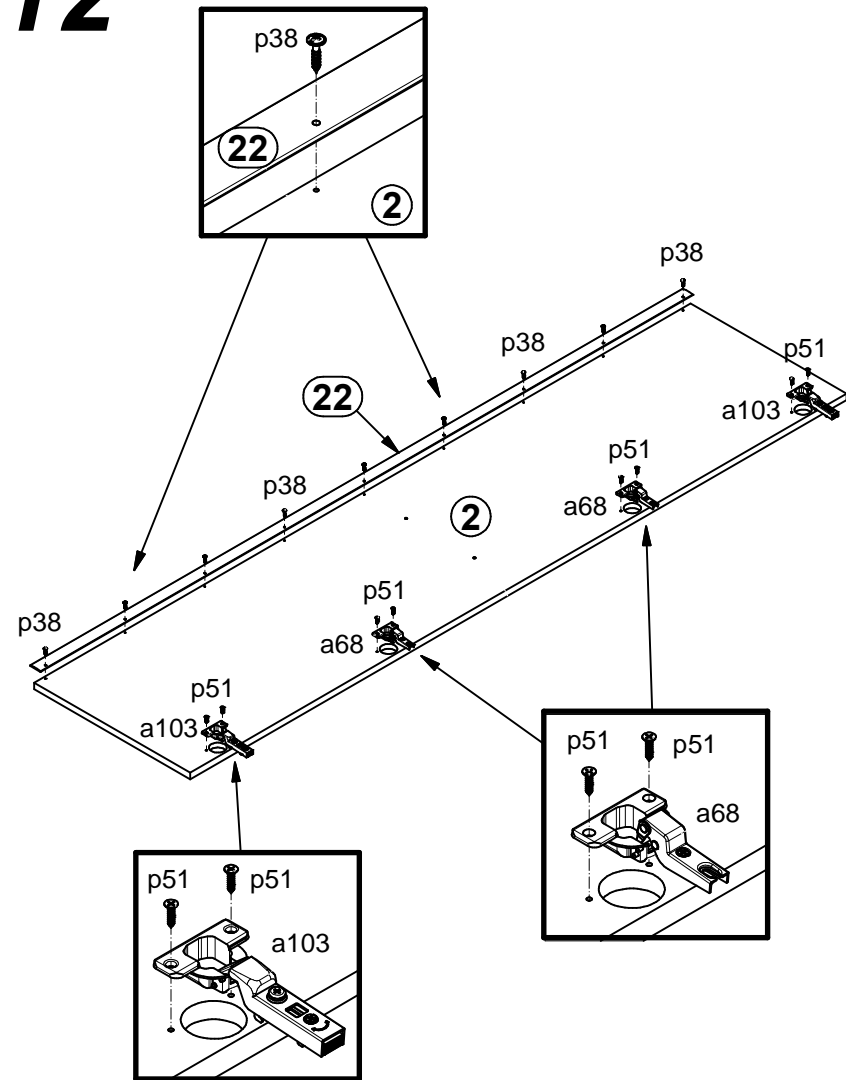

- 6x d36
- 30x l1
- 18x l2
- 10x n108
- 12x p51
- 10x p55

# 12



- 2x  **a103**
- 2x  **a68**
- 1x  **c280\1**
- 2x  **j30**
- 9x  **p38**
- 8x  **p51**

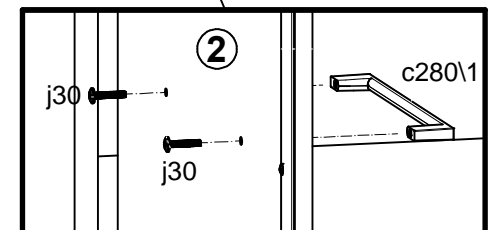
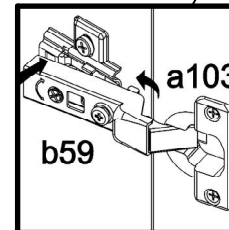

# 13

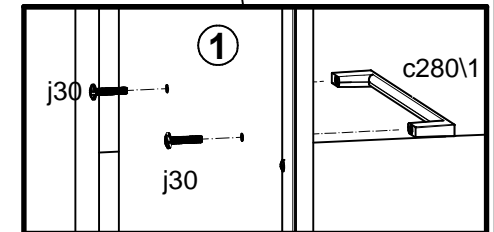
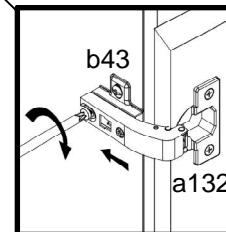
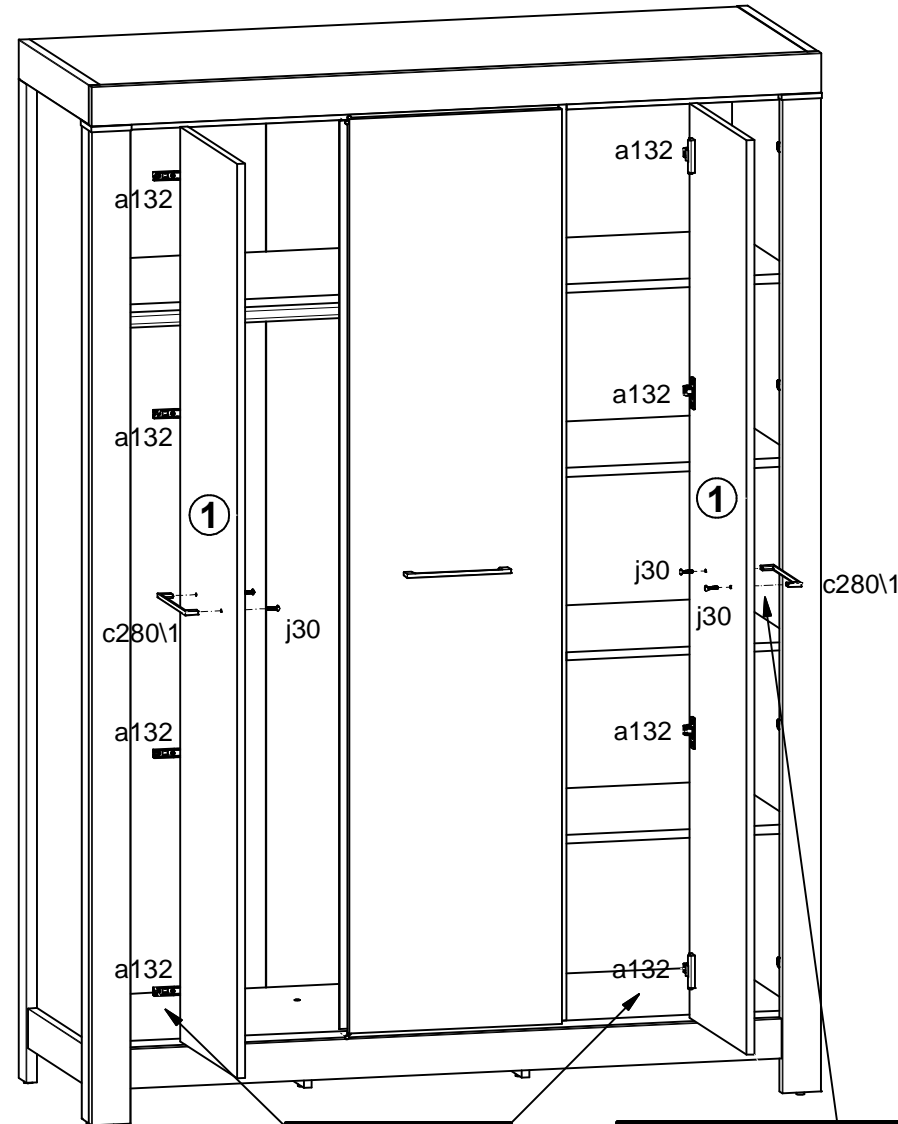
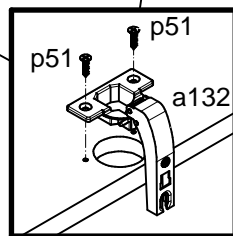
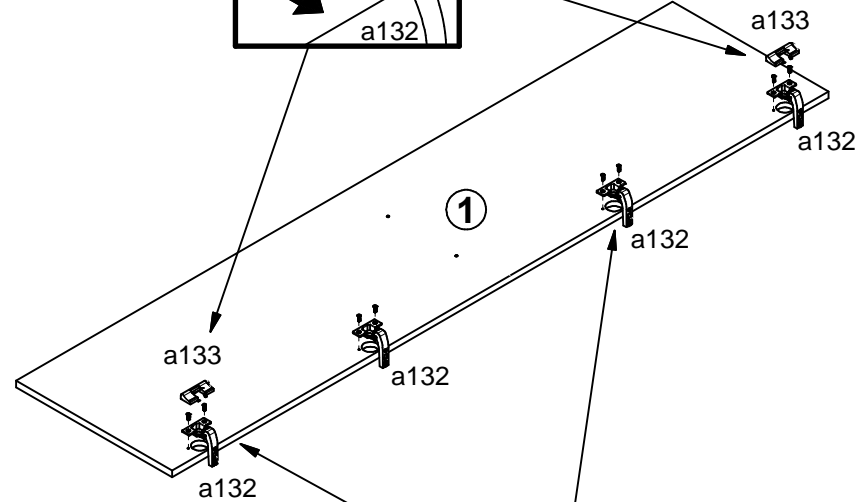
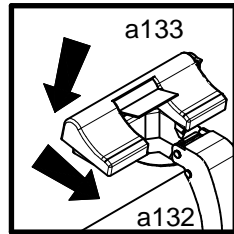
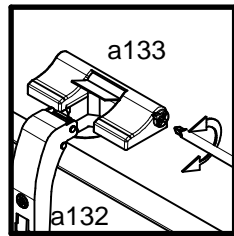

- 8x  a132
- 4x  a133
- 2x  192 mm c280\1
- 4x  M4x22 mm j30
- 16x  Ø3,5x15 mm p51

# 14

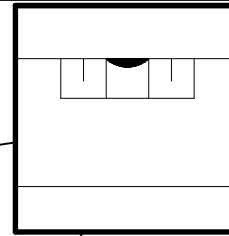
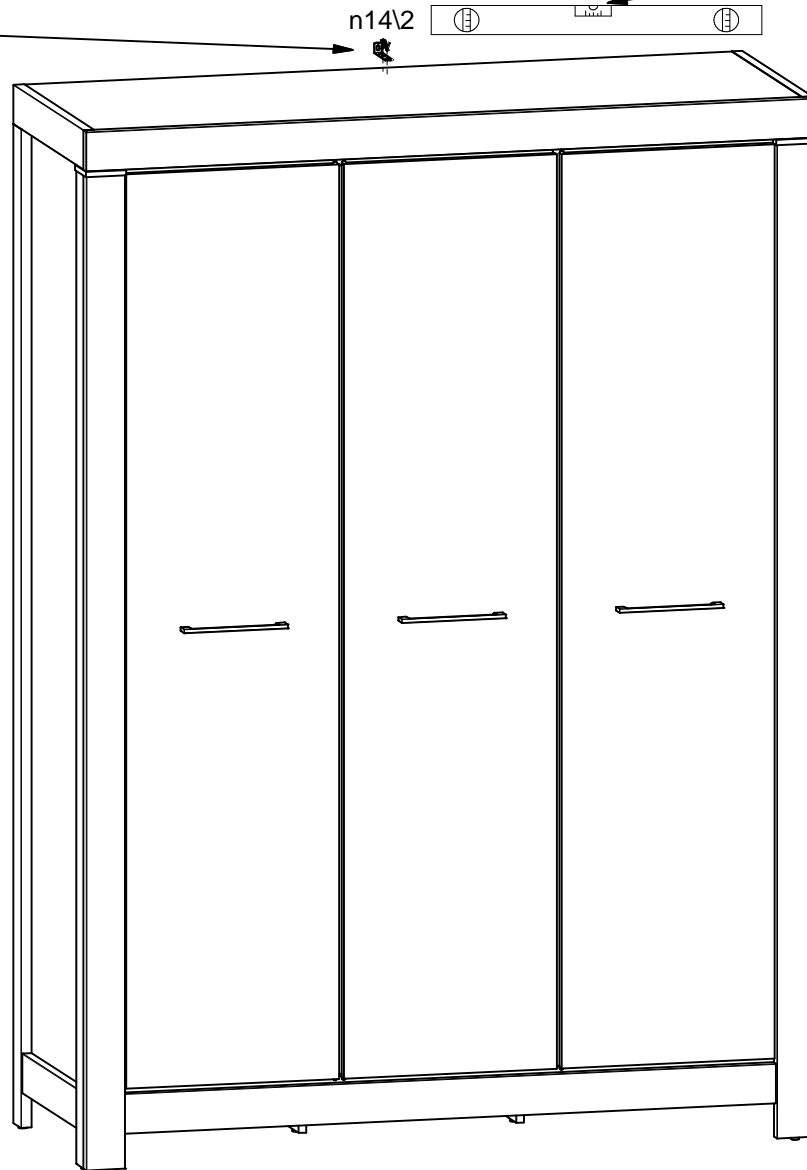
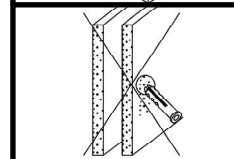
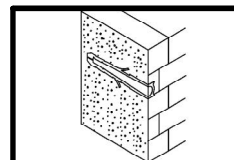
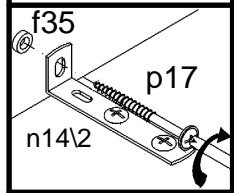
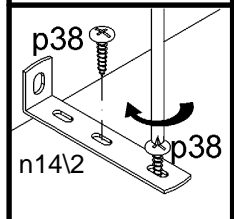
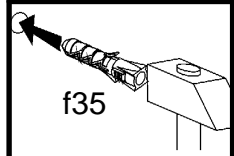
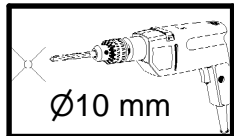

1x Ø10x50 mm f35	1x 86x21x151.5 n142
1x Ø5x60 mm p17	2x Ø3.5x16 mm p38
20x s1	17x Ø16 s2

